

FT-757GX
OPERATING
MANUAL

Downloaded by

Amateur Radio Directory

YAESU MUSEN CO., LTD.
C.P.O. BOX 1500
TOKYO, JAPAN

TABLE OF CONTENTS

GENERAL DESCRIPTION	1
SPECIFICATIONS	3
SEMICONDUCTORS	5
FRONT PANEL CONTROLS	6
REAR PANEL CONTROLS AND CONNECTORS	11
TOP COVER (KEYING) CONTROLS	13
INSTALLATION	14
INTERCONNECTIONS	18
PLUG CONNECTIONS	20
MICROPHONES	21
OPERATION	22

Downloaded by

Amateur Radio Directory

FT-757GX HF ALL MODE COMPUTER AIDED TRANSCEIVER

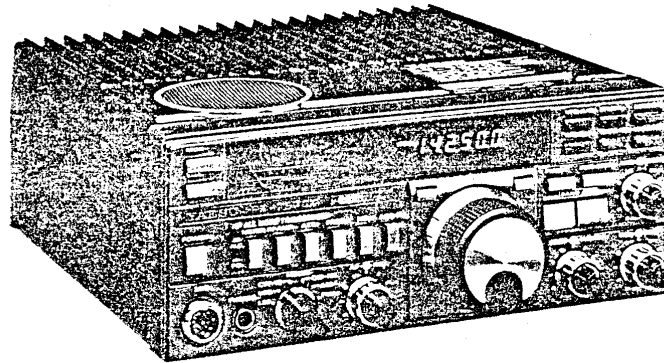

GENERAL DESCRIPTION

The FT-757GX incorporates the finest features of the latest developments in Amateur transceiver design, with the most recent advances in microprocessor technology and computer-aided manufacturing techniques, to provide full performance all mode operation as standard on all HF amateur bands, as well as continuous general coverage reception from 0.5 to 30 MHz.

Yaesu's famous IF Shift/Width passband control system allows the operator an almost infinite variety of selectivity settings for minimizing interference during SSB, CW and ECSS reception of AM signals. Wideband AM and narrowband CW filters are also included — as standard accessories. A switchable RF amplifier and 20 dB attenuator are provided to optimize sensitivity and dynamic range under any conditions, while the noise blanker has its own AGC adjustable from the front panel, from narrow (ignition-type) to wide (woodpecker) blanking pulse widths.

The diecast top half of the FT-757GX provides a glimpse of the revolutionary engineering concepts behind the unique transmitter design, which utilizes a new Duct Flow Cooling system to force air throughout the entire transceiver. The thermodynamic efficiency of this system makes the FT-757GX by far the smallest transceiver of its kind, yet easily capable of full power (100 W output nominal) RTTY and FM transmission when used with an appropriate heavy duty power supply.

The FT-757GX offers full break-in QSK CW operation plus Yaesu's new custom-designed iambic electronic keyer with dot memory using a 4-bit microprocessor built in, as a standard feature. When operating split-frequency QSK, the FT-757GX provides an automatic momentary check of the transmitting frequency before jumping to the receive frequency, so the operator can watch both frequencies for activity at the same time.

For SSB and AM signal punch, the AF speech processor circuit in the FT-757GX is a combination AF clipper and compressor designed to provide the optimum possible increase in average speech power with minimum distortion of the signal. Careful filtering before the modulator assures clean output, with a substantial increase in average power.

The completely new dual PLL synthesis scheme provides tuning steps of 10 Hz, incorporating an 8-bit microprocessor which the operator controls from the tuning knob, optional scanning microphone buttons or external home computer (via the CAT System optional Interface Unit). Front panel keys and buttons are also provided for accessing and interchanging eight memory channels plus two VFOs (A/B) and a clarifier with unlimited frequency range, as well as the PMS (Programmable Memory Scan) system, which allows automatic scanning between two memory channel frequencies with auto stop on those above a preset signal level. All of these features can also be controlled through the CAT system. An internal lithium battery provides complete backup for the memories and VFOs, for 5 years or more.

The three internal microprocessors perform many of the functions that previously required large numbers of discrete components and controls, so that the simplicity of the FT-757GX, inside and out, belies the highly advanced features available to the operator. The CAD/CAM systems used to lay out and assemble the circuit boards provides a clean, orderly design that is uncluttered and easy to service, while reducing the possibility of human assembly errors to almost nil.

Optional accessories include your choice of the MD-1B8 Desktop Scanning microphone or MH-1B8 Handy Scanning microphone. Also, Yaesu has designed the FC-757AT Fully Automatic Antenna Tuner to match the FT-757GX perfectly in all respects. Incorporating its own microprocessor and lithium-backed memory, the FC-757AT can quickly tune your antenna system for minimum SWR at the transmitting frequency with just the touch of a button, and then store the settings in memory for almost instant recall at a later time. The FC-757AT accepts two antennas — or as many as five when used with the FAS-14R Remote Antenna Selector.

Special high duty-cycle power supplies designed for the FT-757GX include the ultra-compact FP-757GX Switching Power Supply and the FP-757HD Heavy Duty Series Regulator Power Supply with forced-air cooling and automatic thermal fan control. For light-duty applications, the FP-700 standard power supply may be used.

Please read this manual carefully to obtain optimum performance and enjoyment from the FT-757GX.

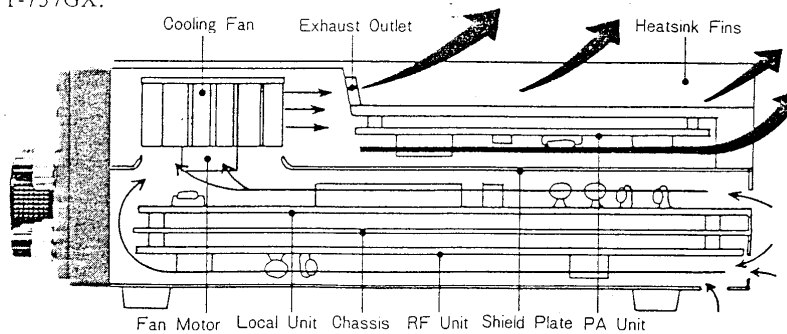

FT-757GX Duct Flow Cooling System

SPECIFICATIONS

TRANSMITTER

Frequency range:

160 m band	1.5 to 1.99999 MHz
80 m band	3.5 to 3.99999 MHz
40 m band	7.0 to 7.49999 MHz
30 m band	10.0 to 10.49999 MHz
20 m band	14.0 to 14.49999 MHz
17 m band	18.0 to 18.49999 MHz
15 m band	21.0 to 21.49999 MHz
12 m band	24.5 to 24.99999 MHz
10 m band	28.0 to 29.99999 MHz

Tuning steps:

10 Hz and 500 kHz (band step)

Emission types:

LSB, USB (A3J/J3E*), CW (A1/A1A*),
AM (A3/A3E*), FM (F3/G3E*)

* New emission designation per WARC '79

Power output:

SSB, CW, FM 100 W (PEP/DC) w/slightly less on 10 m
AM 25 W (Carrier)

Carrier suppression:

better than 40 dB below peak output

Unwanted sideband suppression:

better than 50 dB below peak output
(1 kHz tone)

Spurious radiation:

better than 50 dB below peak output

Audio response:

less than -6 dB from 300-3000 Hz

3rd order intermodulation distortion:

better than -35 dB below peak output
(14 MHz, 100 W)

Reference oscillator stability:

better than ± 10 ppm from 0-40°C after
15 min. warm up

Modulation type:

A3J: Balanced Modulator
A3: Low Level Modulator
F3: Variable Reactance Modulator

Maximum FM deviation:

± 5 kHz

Output impedance:

50 ohms (nominal), unbalanced

Microphone impedance:

Low (500 to 600 ohms)

RECEIVER

Frequency range:

500 kHz to 29.99999 MHz (continuous)

Circuit type:

Triple conversion superheterodyne

Clarifier range:

Unlimited

Sensitivity:

(CW, SSB and AM figures measured for 10 dB
S+N/N)

*1.5~30 MHz **500 kHz~1.5 MHz

SSB, CW(W), FSK

*better than 0.25 μ V **better than 2.0 μ V

CW(N)

*better than 0.16 μ V **better than 1.25 μ V

AM

*better than 1.0 μ V **better than 8.0 μ V

FM

better than 0.6 μ V for 12 dB SINAD

Intermediate frequencies:

1st IF: 47.060 MHz

2nd IF: 8.215 MHz

3rd IF: 455 kHz

FM IF: 455 kHz

Image rejection:

better than 70 dB

IF rejection:

better than 70 dB for all frequencies

Downloaded by



Amateur Radio Directory

Selectivity (adjusted for maximum IF width):

	-6 dB	-60 dB
SSB, CW(W), FSK	2.7 kHz	4.5 kHz
CW(N)	600 Hz	1.3 kHz
AM	6 kHz	18 kHz
FM	15 kHz	30 kHz

NOTE: These figures apply as maximum bandwidths with Width control set to maximum.

Dynamic range:

better than 100 dB (CW(N), 14 MHz)

Audio output power:

3 watts minimum (into 4 ohms, with less than 10% THD)

Audio output impedance:

4 to 16 ohms

GENERAL

Voltage:

13.5 V DC

Power consumption:

Receiver: 2 A
Transmit (100 W output): 19A

Dimensions (WHD):

approximately 238 mm x 93 mm x 238 mm;
w/o feet and knobs, but w/heatsink

Weight:

approximately 5.2 kg (11.5 lb.)

Specifications subject to change without notice or obligation

ACCESSORIES

Supplied

DC Power Cord	(T9014900)	1
(w/out Fuse)		
Spare Fuses		2
FT-757GX	20A (Q0000009)	
FT-757SX	6A (Q0000012)	
3-pin Phone Plug	SH3603 (P0090008)	1
(Electronic Keyer)		
RCA Plugs	STP-58 (P0090018)	2

Options

Desktop Microphone	MD-1B8 (D1000039)
Hand Microphone	MH-1B8 (D1000040)
Relay Box	FRB-757 (D3000328)
Microcomputer Interface Units	
(Apple II)	FIF-65 (D3000280)
(IEEE RS-232C bus)	
	FIF-232C (D3000307)

Switching Power Supply	FP-757GX
Heavy Duty Power Supply	FP-757HD
Standard Power Supply	FP-700
Fully Automatic Antenna Tuner	FC-757AT
Remote Antenna Selector	
(use w/FC-757AT)	FAS-1-4R
External Speaker	SP-102
Phone Patch Speaker	SP-102P
Monoband V/UHF Transverter	FTV-700
6m Module for FTV-700	FTV-6m
2m Module for FTV-700	FTV-2m
70cm Module for FTV-700	FTV-70cm
Connection Cable for Full	
Break-in Linear Amplifier	T9101295A

SEMICONDUCTORS

<p>ICs</p> <p>AN6551 1</p> <p>AN6552 3</p> <p>HD10551P 2</p> <p>MB3713 1</p> <p>MC3359 1</p> <p>MC14011B 4</p> <p>MC14013B 1</p> <p>MC14028B 1</p> <p>MC14042B 1</p> <p>MC14049UB 1</p> <p>MC14066B 2</p> <p>MC14071B 1</p> <p>MC14082B 1</p> <p>MC14510B 1</p> <p>MC14518B 1</p> <p>MC14584B 1</p> <p>MC145145 2</p> <p>MC146805G2P (SC82072P) 1</p> <p>SN16913P 3</p> <p>SN74LS145N 1</p> <p>SN76514N 3</p> <p>TMS1751C 1</p> <p>TMS2370 1</p> <p>TL7705 1 (GX)</p> <p>μPC78L05 2</p> <p>μPC78L08 1 (SX)</p> <p>μPC7808H 1 (SX)</p> <p>μPC7808H 2 (GX)</p> <p>FETs</p> <p>2SK107-3 5</p> <p>2SK125 7</p> <p>2SK192AGR 2</p> <p>2SK241GR 1</p> <p>3SK73GR 7</p>	<p>Transistors</p> <p>2SA733AP 6</p> <p>2SA733AQ 9</p> <p>2SA952L 1 (GX)</p> <p>2SA1012Y 2</p> <p>2SA1193K 2</p> <p>2SC380TMY 23</p> <p>2SC458B 26</p> <p>2SC458D 3</p> <p>2SC496Y 1</p> <p>2SC535B 17</p> <p>2SC1923O 1</p> <p>2SC1971 1 (GX)</p> <p>2SC2166 1 (SX)</p> <p>2SC2395 2 (GX)</p> <p>2SC2509 2 (SX)</p> <p>2SC2879 2 (GX)</p> <p>2SD8800 1 (GX)</p> <p>2SD882Q 1 (SX)</p> <p>2SD892R 2</p> <p>2N4427 2</p> <p>Germanium diodes</p> <p>1N270 4</p> <p>Silicon diodes</p> <p>1S1554 1</p> <p>1S1555 4 44</p> <p>1SS55 1</p> <p>10D10 4 (GX)</p> <p>MA190 73</p> <p>Schottky barrier diodes</p> <p>1SS97 16</p> <p>1SS101 1</p> <p>1SS106 11</p>	<p>Varactor diodes</p> <p>1SV50 2</p> <p>1SV103 4</p> <p>FC52M-5 1</p> <p>FC53M-5 2</p> <p>Zener diodes</p> <p>HZ3C1 2</p> <p>HZ4B3 2</p> <p>HZ5C1 1</p> <p>RD5.1EB 1</p> <p>RD5.1EB2 2</p> <p>RD6.2EB3 1</p> <p>RD7.5EB3 1</p> <p>RD8.2EB3 1</p> <p>RD9.1EB2 3</p> <p>RD9.1EB3 2</p> <p>RD30EB2 1</p> <p>LED</p> <p>LN410YP 1</p> <p>Ring Modules</p> <p>ND487R1-3R 1</p> <p>ND487C2-3R 1</p> <p>Varistor diodes</p> <p>MV11 1 (SX)</p> <p>MV12 1</p> <p>MV103 1</p> <p>FCD</p> <p>FIP9E7 1</p>
--	--	--

FRONT PANEL CONTROLS

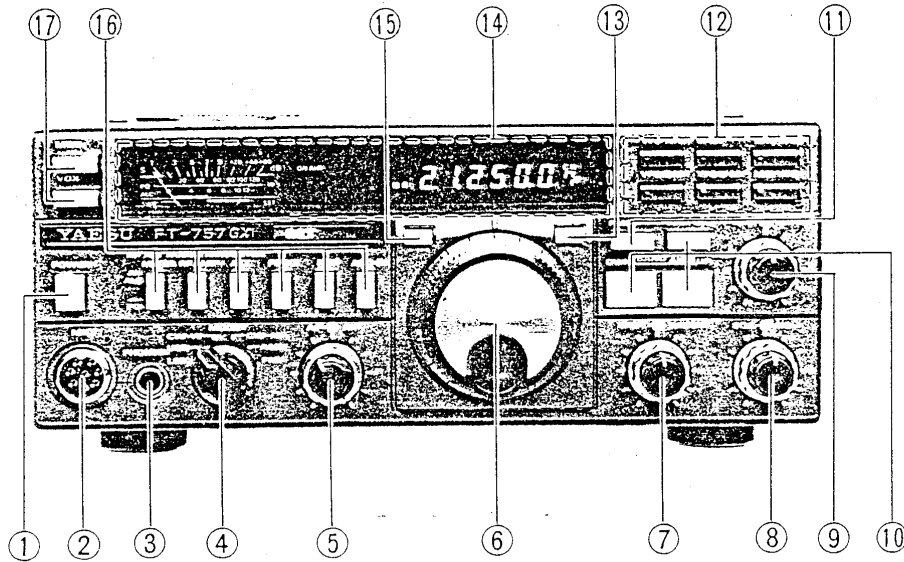

① POWER

This is the main on/off switch for the transceiver. Frequency data stored in the memories and VFOs is not affected by this switch, or by whether power is supplied to the transceiver or not, since this data is retained in RAM by the internal lithium battery when the backup system is activated.

② MICROPHONE

This 8-pin connector accepts the microphone plug. When a scanning microphone is used, such as the MD-1B8 desk microphone or the MH-1B8 hand microphone, the scanning buttons on the microphone can be used to scan the transceiver operating frequency in 10 Hz steps, slow or fast. Pin connection details are provided on page 21. Microphone impedance should be 500-600 ohms.

③ PHONES

Standard monaural or stereo headphones with 4-16 ohms impedance may be connected to this jack. Stereo headphones with a 3-conductor plug will reproduce the audio in both ears, as with monaural headphones with a 2-conductor plug. Inserting a plug into this jack disables the internal speaker, or external speaker, if connected.

④ MODE

This selector determines the operating mode of the transceiver. The CW-W (wide) position activates an internal AF filter, while the IF filter is the same as for SSB. The CW-N (narrow) position activates the 600 Hz narrow IF filter for further enhanced selectivity. The USB (upper sideband) position is for SSB operation generally above 10 MHz, and LSB (lower sideband) is for SSB operation below 10 MHz and normal RTTY operation.

⑤ AF → RF

The inner AF control adjusts the level of the audio gain of the receiver. Rotate this control clockwise to increase the volume.

The outer RF gain control adjusts the gain of the RF and IF amplifiers via the AGC line during reception. This control is normally set to the fully clockwise position for maximum receiver sensitivity and optimum amplifier linearity. When the RF gain control is rotated counterclockwise from its maximum position the S-meter minimum deflection point will move up the scale. The peak deflection for a given signal will remain the same as long as it is greater than the point of minimum deflection set by this control, but the receiver will

not respond to weaker signals. This control also affects the squelch (SQL) control, and should be set fully clockwise when setting the squelch threshold point.

⑥ Tuning Knob

The shaft of this control is connected to the photo-interrupter encoder to produce the pulses used to change the operating frequency of the transceiver in 10 Hz steps. One rotation of the knob produces 10 kHz of frequency change, and continuous rotation allows tuning any frequency within the 500 kHz-30 MHz range of the transceiver. This knob is disabled by several functions, as described on page 22. A turning torque adjustment screw for the Tuning Knob is accessible through the hole on the bottom of the transceiver, just beneath the knob (page 10).

⑦ SHIFT WIDTH

The inner SHIFT control tunes the relative position of the receiver IF passband with respect to the frequency to which the receiver is tuned during SSB, CW and AM reception. Turning the control clockwise raises the center frequency of the passband, while turning it counterclockwise lowers the center frequency. When set to the 12 o'clock position the passband center frequency is aligned with the frequency shown on the display.

The outer WIDTH control adjusts the IF bandwidth of the receiver during SSB and CW reception. Maximum bandwidth is provided when this control is set to the 12 o'clock position, and is equal to the combined selectivity of the IF filters for SSB (when an SSB or CW-W mode is selected), or the CW-N filter plus one of the SSB filters when the CW-N mode is selected. Clockwise rotation moves the lower skirt of the IF passband higher in frequency, and counterclockwise rotation moves the upper skirt downwards. During AM reception, the WIDTH control functions in the same way as the SHIFT control.

⑧ SQL NB

The inner SQL (squelch) control sets the threshold level at which the receiver audio is disabled during reception of all modes. This threshold point also serves as an automatic scan halt setting for the PMS (Programmable Memory Scan) system described

later. Clockwise rotation increases the threshold point, causing the receiver not to respond to weaker signals.

The outer NB (noise blanker) control adjusts the time constant of the noise blanker AGC, which determines the width of the blanking pulse when the noise blanker is activated, during reception of SSB and CW (and AM when the amplitude of the noise exceeds that of the received carrier).

⑨ MIC DRIVE

The inner MICrophone gain control adjusts the gain of the microphone audio amplifier in the transmitter during SSB and AM transmission (FM microphone gain is preset internally). This control may be used to adjust the output power for SSB when the speech processor is off.

The outer -DRIVE control adjusts the level of the carrier during CW, AM and FM transmission, to allow adjustment of the output power in these modes. The DRIVE control is disabled during SSB transmission.

⑩ BAND/CH (DWN and UP keys), and 500k STEP button

This pair of momentary switches can be used for tuning the VFOs in conjunction with the tuning knob and the 500k STEP (two-position) button. When the 500k STEP button is not depressed, pushing the -DWN or UP key will cause a beep to sound and the VFO frequency to move down or up one amateur band. If the VFO frequency is in the 1.8 MHz amateur band and the DWN button is pressed, the VFO will change to the 28 MHz amateur band; and vice-versa. The digits of frequency to the right of the 100 kHz digit will not be affected by these keys. (Hold a key to repeat the stepping.)

When the 500k STEP button is depressed (while operating on a VFO) and one of the BAND/CH keys is pressed, the VFO frequency steps up or down 500 kHz. This allows rapid QSY from one part of the 28 MHz amateur band to another, as well as general coverage operation outside of the amateur bands, between 500 kHz and 29.9999 MHz.

When a memory channel is recalled (as described later), the 500k STEP button will be disabled, and the BAND/CH DOWN and UP keys will then function as memory channel selectors, stepping through the memory channels in their respective directions.

⑪ PMS (Programmable Memory Scan)

Press this key to activate automatic receiver scanning between the frequency stored in the selected memory channel and the next higher-numbered channel. When the PMS system is activated, the display will show "MR" to the left of the displayed operating frequency, and "P" in the "CH" position to the right of the frequency. The scanner will stop whenever a signal appears that is strong enough to open the squelch, as set by the SQL control. Close the squelch and press the PMS key again to resume scanning. To cancel PMS operation and place the displayed operating frequency in the (last) selected VFO, open the squelch and press the M \rightarrow VFO button once. See the Operation Section (page 35) of this manual for further details.

⑫ VFO and Memory Selection Keys

These six keys transfer the frequency data between the VFO A, VFO B, Memory, Transmitting and Receiving frequency registers used to store operating frequencies for the transceiver. Since these keys function in both transmit and receive, care must be exercised not to press them inadvertently during transmission. When any of these keys are pressed, a beep will sound. Two keys are marked yellow to indicate that certain frequency data will be lost when one of these are pressed.

VFO A/B

Pressing this key causes the frequency data in the VFO A and VFO B registers to be exchanged. If this key is pressed again the register contents will be exchanged again, returning to the original operating frequency. The VFO A/B key does not affect the operating frequency when operating on a memory channel, but still exchanges the VFO A/B data held in the respective registers.

SPLIT

Pressing this key enables split frequency operation: receiving on one VFO frequency and transmitting on the other VFO frequency.

When pressed, the displayed operating frequency will remain the same until the TX/RX state is changed (PTT line switched). Pressing this key a second time cancels split operation.

MR/VFO

Pressing this key causes the source of the operating frequency to be changed from a VFO to a memory, and vice-versa. The particular VFO register involved in this exchange will be the last one used for operation, and the memory channel will be the last one used for memory operation. The status of the MR/VFO function is indicated on the display by either VFO A, VFO B or MR just to the left of the operating frequency, and by the presence or absence of the operating memory channel number to the right of the frequency display. Note that the actual data remains in the VFO register, and the memory data remains in the selected memory channel.

VFO \rightleftharpoons M

Pressing this key exchanges the actual data stored in the (last) selected VFO with that stored in the (last) selected memory channel. Unlike the previous MR/VFO key, the operating register (VFO or M) does not change, but the operating frequency does change. Pressing this key again returns the memory and VFO frequency data to their original places, and the operating frequency returns to what it was before the first push of this key.

VFO \rightarrow M (yellow marking)

This key writes the frequency data from the selected VFO into the (last) selected memory channel. The operating frequency VFO data remains unaffected in the VFO, but previously stored data in the memory channel is overwritten. Note that the frequency data previously stored in the memory is destroyed. After pressing this key the data in the operating VFO and memory channel will be the same, and previously stored memory data can not be retrieved without manual retuning. Pressing this key when operating on a memory channel will not cause any changes in VFO or memories.

M — VFO (yellow marking)

Note

Do not press this button when operating on a VFO tuned to a band different than in the memory.

This key writes the frequency data from the (last) selected memory channel into the (last) selected VFO, except during PMS operation, as described on page 31. The memory data remains unaffected in the memory, but previous data in the VFO register is overwritten. Note that this key does not affect the operating frequency when operating on a memory, but does destroy the operating frequency data if operating on a VFO (replacing it with the frequency of the last selected memory channel). After pressing this key the data in the respective memory channel and VFO will be the same, and previous data held in the VFO register can not be retrieved without manual retuning. This key destroys the VFO data regardless of whether operation is from the VFO or memory. After pressing this button, operation will always be from the VFO.

⑬ D LOCK

This dial lock button electrically disengages the photo-interrupter tuning mechanism on the shaft of the Main Tuning knob, and also the scanning buttons on the microphone, to prevent the possibility of accidental VFO or clarifier frequency change by inadvertent contact with the Tuning Knob. Pressing this button again returns VFO or clarifier frequency control to the Tuning Knob and scanning buttons.

⑭ Meter and Display

The meter provides relative signal strength indication in S-units on the uppermost scale during reception, and relative forward power output (PO), transmitter automatic level control (ALC) or reflected power output (as SWR) during transmission. The meter function during transmission is determined by the setting of the METER button on the front panel, and the FWD-REV switch and FWD SET control on the rear panel.

To the immediate right of the meter is the ON AIR indicator, which lights whenever the transmitter is activated.

To the right of the ON AIR indicator are status indicators for the dial lock (LOCK), split frequency operation (SPLT), clarifier operation (CLAR), VFO A, VFO B and memory recall operation (MR).

The frequency display provides digital indication of the operating frequency to the nearest 100 Hz. During clarifier operation, the actual clarified receiving frequency will be displayed.

During memory recall operation, the selected memory channel (CH) number, from 1 to 8, will appear to the right of the frequency display.

⑮ CLAR

Pressing this button activates the clarifier function during reception on a VFO. The Tuning Knob and BAND keys can then be used to change the receiving frequency (through the full range of the receiver) without affecting the transmitting frequency. Pressing this button again, when the clarifier is active, cancels the function and whatever offset tuned, so that the receiving frequency returns to that which was last used before the function was activated. The clarifier does not function when operating directly from a memory.

⑯ Push Button Switches

METER

This switch selects the function of the Meter during transmission. In the depressed position, the Meter indicates either forward or reflected power output (PO), as determined by the FWD-REV switch on the rear panel. In the undepressed position, final amplifier ALC is indicated on the Meter, with the safe zone at the left side of the Meter range denoted by the white bar beneath the PO scale. Meter operation (signal strength) during receive is not affected.

RF AMP

In the depressed position, this switch activates the RF amplifier in the front end of the receiver, for maximum receiver sensitivity. In the undepressed position the RF amplifier is bypassed, for increased immunity to intermodulation from strong unwanted signals.

ATT

Pressing this button places a signal attenuator in the receiver front end, to reduce the receiver sensitivity by approximately 20 dB when listening to strong signals.

PROC

When this button is depressed the AF speech processor is activated during SSB transmission. This circuit increases the average power of SSB voice transmissions, to the degree set by the COMP LEVEL control on the rear panel, making the signal more readable under weak signal conditions.

NB

Depressing this button activates the noise blanker during SSB, CW and AM reception. The NB control at the lower right on the front panel can then be used to set the blanking threshold and blanking pulse width.

AGC-F

In the depressed position, this button activates the fast AGC time constants during SSB, CW and AM reception; for tuning, and listening to weak signals. When not depressed, slow AGC is provided for more comfortable reception of strong signals.

⑰ MOX and VOX Push Button Switches

The MOX button allows manual closing of the PTT line. When depressed, the transmitter will remain activated until the MOX button is pressed again (to return to the out position).

The VOX button activates the voice-actuated transmit/receive circuit during SSB, AM and FM; and semi break-in during CW operation. In the voice modes, this function causes the transmitter to be activated automatically when speaking into the microphone, according to the level set by the VOX GAIN control on the rear panel (and the MIC gain control). When finished speaking or releasing the CW key, the receiver will be automatically reactivated after a short delay, as set by the DELAY control on the rear panel.

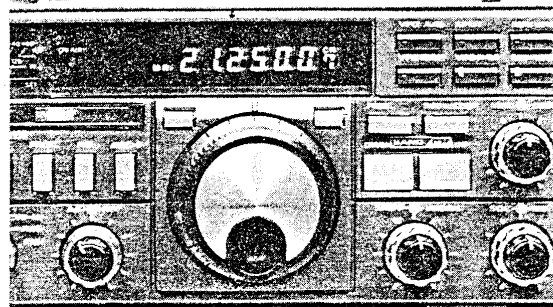

Main Knob Torque
Adjustment Screw

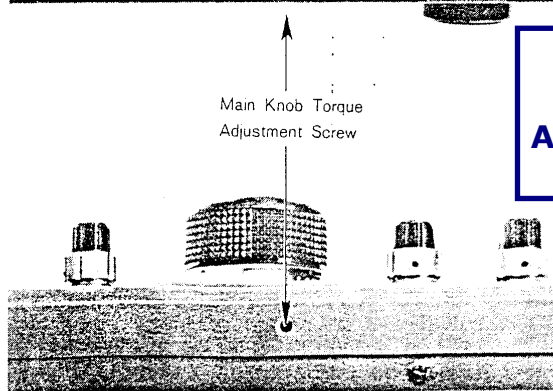

BOTTOM

Downloaded by

Amateur Radio Directory

REAR PANEL CONTROLS AND CONNECTORS

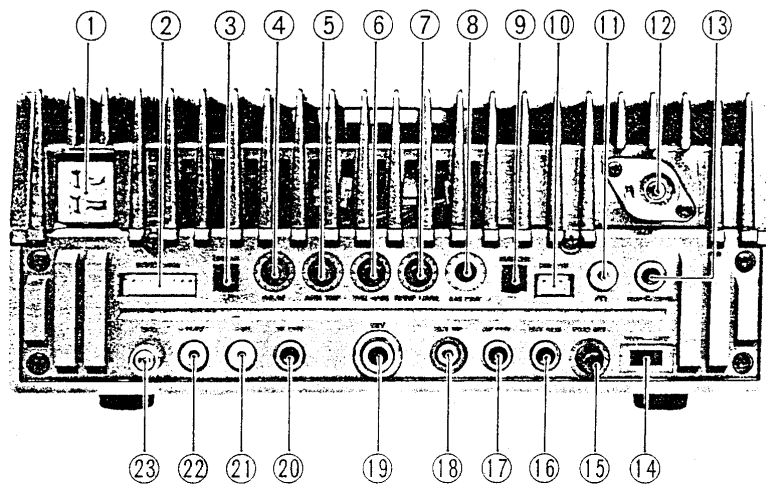

① DC 13.5 V Connector

This connector accepts 12 to 15 VDC at 19 amperes (transmit), to power the transceiver. Do not apply DC voltage outside of this range, or AC voltage, as this will damage the transceiver. The pinout of this connector is shown on page 17. The FP-757GX and FP-757HD are power supplies specifically designed for the requirements of the FT-757GX.

② BAND DATA Connector

This 8-pin moxex connector provides parallel TTL-level band-switching signals and DC power for the FC-757AT automatic antenna tuner. Also, when a QSK linear amplifier is used, pin 6 of this connector provides high speed synchronized switching for T/R control of the linear. However, this circuit cannot handle more than 50 V or 300 mA. Linear amplifiers with relays that use higher voltage or current must be connected with the FRB-757 Relay Box.

③ LINEAR Push Button Switch

This switch is for use when using the FT-757GX with a linear amplifier specifically designed for full break-in (QSK) CW operation, when a QSK amplifier T/R relay closure sensing signal is delivered from the amplifier to the transceiver and also when using the FC-757AT Automatic Antenna Tuner.

In those cases, this switch should be depressed. Otherwise, this switch must be in the out position. If this switch is pressed when the MARKER switch is also pressed, the memory backup circuit will be disabled and all memories will be cleared if power is disconnected.

④ DELAY

This potentiometer sets the delay between the time that speech stops and the time that the receiver is automatically reactivated during VOX operation in the SSB, AM and FM modes. During semi break-in CW operation, this control sets the delay between the time that the key opens and the time that the receiver is reactivated.

⑤ ANTI TRIP

During VOX operation, this potentiometer sets the amount of negative feedback applied to the VOX amplifier from the receiver, which prevents the receiver audio output from the speaker from activating the transmitter via the microphone.

⑥ VOX GAIN

During VOX operation, this control sets the gain of the VOX amplifier, and thus the sensitivity of the VOX circuit to the voice of the operator. The optimum setting of this control depends on the microphone used, as well as the natural voice characteristics of the operator.

⑦ COMP LEVEL

This potentiometer sets the compression level of the audio speech compressor during SSB transmission with the processor on. The adjustment procedure is described in the Operation section of this manual.

⑧ AM CAR

This potentiometer sets the level of the transmitted carrier and modulation during AM transmission. See the operation section for the adjustment procedure.

⑨ MARKER Push Button Switch

Press this switch to activate the 25 kHz marker signal generator, which will produce a crystal-controlled calibration signal at every 25 kHz throughout the tuning range of the transceiver. When not needed, this switch should be in the off (out) position. If this switch is pressed when the LINEAR switch is also pressed, the memory backup circuit will be disabled and all memories will be cleared if power is disconnected.

⑩ REMOTE

This 3-pin mox connector provides access to the serial microcomputer data lines of the CAT system, for control of the transceiver from an external microcomputer through an optional interface unit. (FIF-65, FIF-232C etc.)

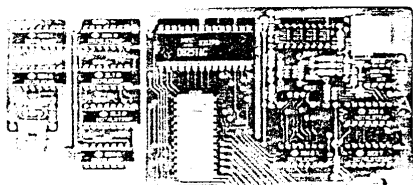

FIF-65

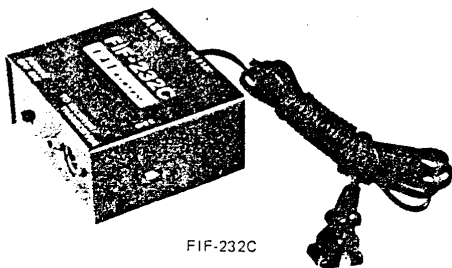

FIF-232C

Microcomputer Interface Units

⑪ PTT

This RCA jack offers access to the PTT line, for external receive/transmit switching by a foot-switch or other device. Connecting the inner contact to the outer contact or ground activates the transmitter. Also, when the FT-757GX is used with a linear amplifier, this jack provides the PTT switching signal for the FRB-757 Relay Box to control the linear. Do not connect your amplifier relay control line directly to this jack.

⑫ ANT

This type M (SO-239) jack is for connection of a 50-ohm unbalanced load, such as an antenna resonant at the operating frequency, an antenna tuner, or linear amplifier input. Use only a type M (PL-259) plug to make connection.

⑬ PATCH/AFSK

This RCA jack accepts input from a phone patch or AFSK tone generator, for application to the transmitter audio amplifier. Impedance is 600 ohms, and the level is adjustable by the MIC gain control when the transceiver is set to an SSB mode.

⑭ FWD-REV Slide Switch

During transmission, when the front panel METER switch is in the (depressed) PO position, this switch provides for selection of either relative forward or reverse power output indication on the meter. The adjacent FWD SET control adjusts the relative amount of deflection, and can be used in conjunction with this switch to provide display of SWR on the meter, as described in the Operation section of this manual.

⑮ FWD SET

This potentiometer adjusts the sensitivity of the Meter during transmission, when the front panel METER switch is set to the PO position. Use this control in conjunction with the FWD-REV switch to set the Meter for full-scale deflection in the FWD position, so that SWR can be read from the Meter in the REV position.

⑯ EXT ALC

This RCA jack accepts automatic level control for the transmitter from an external linear amplifier. The range of this voltage should be between 0 and -5 VDC, referenced to the outer contact (ground).

⑰ AF OUT

This RCA jack provides constant, low-level audio output from the receiver, unaffected by the AF gain control setting, for data decoding modems or similar applications. Output level is approximately 200 mV peak at 50 kilohms.

⑱ EXT SPeaker

This standard 1/8-inch 2-conductor mini phone jack provides for connection of an external speaker with impedance of 4 to 16 ohms.

⑲ KEY

This standard 1/4-inch 3-conductor phone jack accepts either a standard CW key or keyer paddles (for the internal electronic keyer). A 3-conductor plug must be used. Wiring connections are shown on page 20. Open circuit voltage is +5 V DC, and closed circuit current is 0.5 mA.

⑳ RF OUT

This RCA jack provides low-level RF output from an early stage of the transmitter, for exciting a

transverter such as the FTV-700. Power level is approximately -6 dBm (0.1 Vrms) at 50 ohms.

㉑ +8 V

This RCA jack provides 8 V DC at up to 100 mA for the FTV-107 Transverter or other accessories. The center contact is positive.

Note: Repairs to damage caused by exceeding the current ratings of the accessory DC jacks may not be covered by the warranty policy.

㉒ +13.5 V

This RCA jack provides 13.5 V DC at up to 500 mA across the center and outer contacts, for powering accessories. The center contact is positive.

㉓ GND

For best performance and safety, this terminal should be connected to a good earth ground through the shortest path possible.

TOP COVER (KEYING) CONTROLS

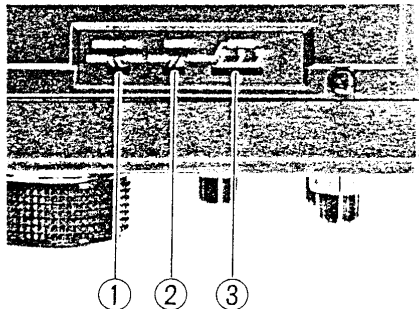

① BREAK-IN

When the VOX switch on the front panel is in the undepressed position, this switch selects between CW sidetone (only) operation (SEMI position), and CW full break-in QSK transmission (FULL position). In this case, when this switch is set to the SEMI position, no transmission will occur, though the CW sidetone will be heard when the key is closed. This is ideal for CW practice.

If the VOX switch is depressed, this switch is disabled, and CW semi break-in operation occurs. Use the DELAY control on the rear panel to adjust the transmit hang time.

② KEYER

When this slide switch is set to the AUTO position, the internal 4-bit keyer microprocessor is activated. To operate the keyer, an appropriate paddle keyer manipulator must be connected through a 3-conductor phone plug to the KEY jack on the rear panel. Set this switch to the MAN (manual) position when using a straight key or bug. Either semi or full break-in operation can be used with this switch in either position.

③ SPEED

This slide potentiometer adjusts the keying speed of the automatic keyer, when the KEYER switch is set to the AUTO position and the keying paddles are pressed. Slide this control to the right for faster keying speed.

INSTALLATION

PRELIMINARY INSPECTION

Upon opening the packing carton, immediately give the transceiver a thorough visual inspection. Check to ensure that all controls and switches move freely, and that the cabinet is free from any signs of damage. If any damage is noticed, immediately document the damage completely and contact the shipping company. Save the packing carton and packing material for possible future use.

BASE STATION INSTALLATION

AC Power Supply

The FT-757GX requires a power source of 13.5 (± 1.5) volts DC, capable of up to 20 amps on voice peaks. For base station installations, Yaesu offers a variety of AC power supplies, all of which may be used with AC line voltages of 100, 110, 117, 200, 220, or 234 VAC. However, before connecting any power supply to the transceiver or AC line, make certain that the supply is properly set up for the local line voltage, and that the correct fuse is installed.

The FP-757GX is a compact switching power supply capable of 50% duty-cycle with full power operation for up to 30 seconds at a time. AC supply voltage is selectable for either 85 to 132 VAC, or 178 to 264 VAC, by installing the internal jumper connector as shown below. A 5-amp fuse is required for either AC range. The fuse is located inside the power supply as shown below.

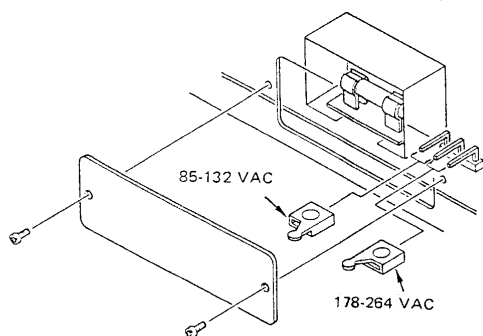

The FP-757HD is a heavy-duty series regulator power supply capable of 50% duty-cycle with full power operation for up to 30 minutes at a time. Forced-air cooling is provided, along with an extra large internal heatsink. Styled to match the FT-757GX, the FP-757HD requires a 6 A fuse for 100, 110 or 117 VAC, or a 3 A fuse for 200, 220 or 234 VAC. Power transformer primary connections for the various line voltages are shown on the next page.

The FP-700 and FP-707 power supplies may also be used with the FT-757GX, but are recommended only for light duty operation, such as SSB or CW. Fuse requirements and power transformer wiring are the same as for the FP-757HD, mentioned above and illustrated in the diagram on the next page, but the plastic sleeve on the supply DC cable must be cut to allow connection of the speaker in the power supply.

NEVER CONNECT AC POWER OR DC VOLTAGE ABOVE 15V DIRECTLY TO THE FT-757GX.

Make certain that the POWER switch on the front panel of the FT-757GX is OFF (out) before connecting power to the transceiver, and double check to make sure that the polarity of the connections is correct before switching the transceiver on.

NOTICE

THE FOLLOWING ABUSES MAY CAUSE DAMAGE TO THE EQUIPMENT WHICH WILL VOID THE WARRANTY:

1. CONNECTION OF AC VOLTAGE OR IMPROPER DC VOLTAGE DIRECTLY TO THE TRANSCEIVER.
2. INCORRECT (REVERSED) POLARITY POWER CONNECTION.
3. USE OF AN IMPROPER FUSE.

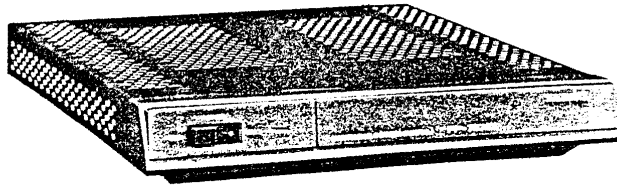

FP-757GX

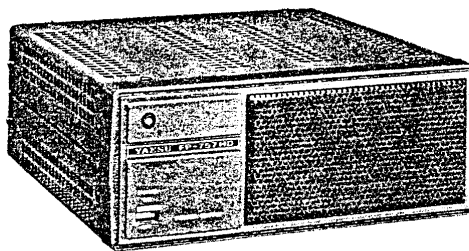

FP-757HD

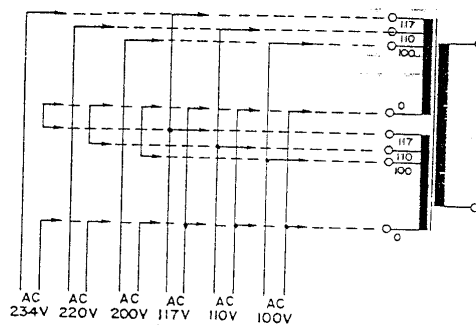

FP-757HD POWER TRANSFORMER PRIMARY CONNECTIONS

Downloaded by

Amateur Radio Directory

Ground and Location

In base station installations the GND terminal on the rear panel of the FT-757GX should be connected by a heavy braided cable to a good earth ground. Best performance will usually result when the grounding cable is less than 10 feet (3 meters) long, where possible. All station equipment should be connected to the same grounding point close to the transceiver, or linear amplifier, if used.

Locate the transceiver so that air can flow freely over the heatsink, and under and behind the case. Whenever possible, use the support bail in the extended position, and avoid placing anything on top of the transceiver. Do not place the FT-757GX on top of a heat generating device such as a linear amplifier. However, the FT-757GX may be placed directly on top of the FP-757GX with or without the bail extended, as the FP-757GX is designed to dissipate heat around its sides.

Antenna

The FT-757GX is designed for use with any antenna system which has a 50-ohm resistive impedance at the operating frequency. An automatic final protection (AFP) circuit is included in the transmitter stages to protect the final transistors by automatically reducing the transmitter power output when a high SWR is present. At an SWR of 3:1 for example, only about 75% of the full rated output power will be available.

In spite of this protection circuit, the FT-757GX should never be switched to transmit when no antenna or dummy load is connected. Use 50-ohm coaxial cable to connect the transceiver to the antenna or load, and if the SWR is too high to permit the desired output power, connect an antenna tuner such as the FC-757AT (automatic) or FC-700 between the transceiver and the antenna. See pages 18 through 20 for interconnection information.

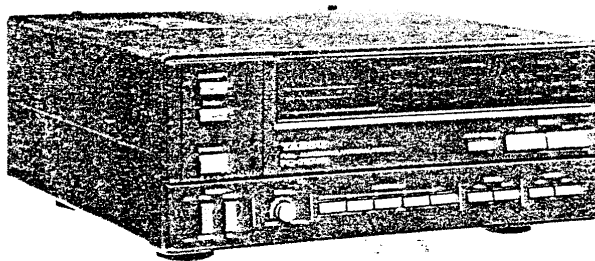

FC-757AT
FULLY AUTOMATIC ANTENNA TUNER

LAMP FUSE PROTECTOR FOR THE RECEIVER FRONT END

If the receiver is found to have suddenly lost sensitivity, check Lamp Fuse F₁₀₀₁ on the RF Unit. This protective device prohibits destructive voltage from reaching the receiver RF amplifier, but if the voltage is excessive it may cause the Lamp Fuse to burn out (even if the transceiver is off at the time).

Before replacing the Lamp Fuse, check to determine just what caused high voltage to be applied to the antenna jack, and take appropriate actions to ensure that it will not recur. To obtain replacement Lamp Fuses ask your local dealer for F₁₀₀₁, part number Q1000010, BQ041-22803A; or substitute any 8V, 100 mA pilot lamp. Do not jumper across the Lamp Fuse terminals however, as this will endanger the delicate semiconductors in the receiver.

MOBILE INSTALLATION (Negative Ground Vehicles Only)

The DC cable for mobile installation is supplied with the transceiver. Please review the NOTICE on page 14 before making power connections. For best results, the DC cable should be connected directly to the vehicle battery, rather than to the ignition circuitry or accessory circuitry. Route the cable as far away from ignition cables as possible, while still keeping the DC cable length as short as practical. Cut off any unnecessary length of the cable in order to keep cable losses to a minimum.

Make certain that the cable is not connected to the transceiver until after the proper connections are made to the battery: the RED cable lead to the POSITIVE battery terminal, and the BLACK lead to the NEGATIVE terminal. The Power Plug Connector Wiring (below) shows the proper polarity of the connections to the FT-757GX. The positive RED wire must include a 20 amp fuse. This must be installed in the supplied cable.

Before connecting the DC cable to the transceiver, check the voltage across the battery terminals with the engine running fast enough to show a charge. If this voltage exceeds 15 volts the automobile voltage regulator must be adjusted to reduce the charging voltage. Once the charging voltage at the battery terminals is determined to be correct, make sure that the POWER switch on the front panel of the FT-757GX is OFF, and connect the DC cable to the transceiver.

Always check to ensure that the FT-757GX POWER switch is in the OFF (out) position before starting the engine.

Mounting

The mobile mounting position should allow about 8 inches (20 cm) of clearance around the heat sink to permit free air circulation. Avoid locations directly in the path of the heater ducts.

Mobile Antenna

Please review the Antenna paragraphs in the preceding Base Station Installation section. An antenna tuner such as the FC-757AT is particularly desirable for mobile installations, where the shortened antenna elements have very narrow bandwidth. Yaesu offers the RSL series of HF mobile antennas.

CAUTION

BE CERTAIN THAT ALL CONNECTIONS TO THE BATTERY ARE TIGHT, AS LOOSE CONNECTIONS CAN CAUSE SEVERE DAMAGE TO THE TRANSCEIVER AND ELECTRICAL SYSTEM OF THE CAR. CHECK BATTERY CONNECTIONS PERIODICALLY.

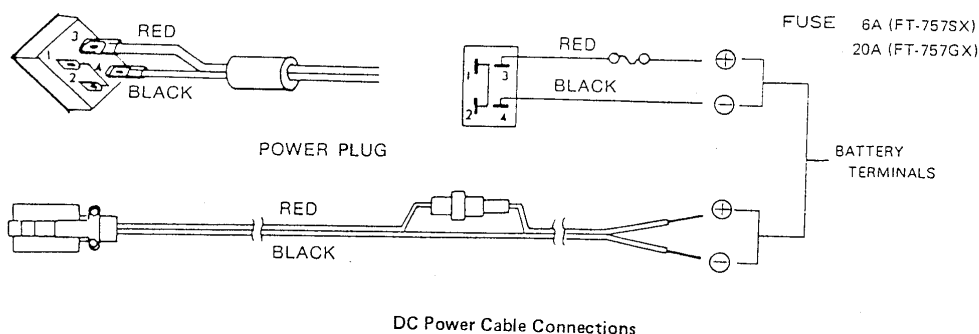

INTERCONNECTIONS

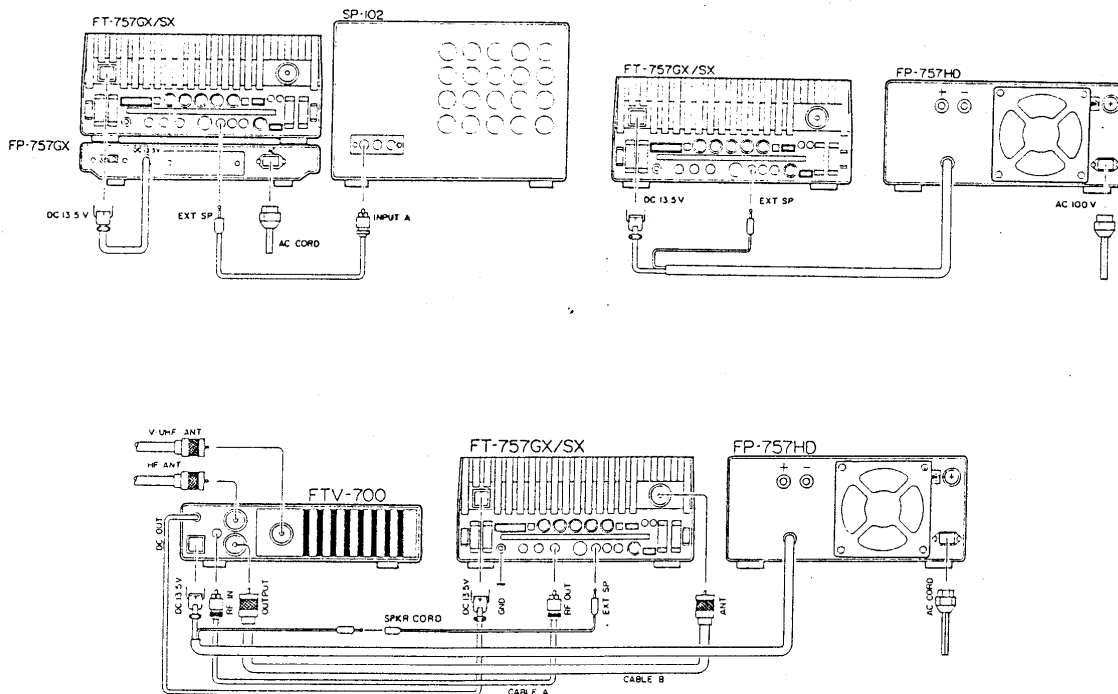

LINEAR AMPLIFIER INTERCONNECTION

Before connecting the linear amplifier to the transceiver, check to be sure that the T/R relay in the amplifier has a back pulse cancelling diode connected across the relay coil. If not, install a general-purpose diode of sufficient voltage rating.

The FT-757GX includes a small, quiet, high-speed T/R relay that makes QSK operation fast and enjoyable. However, when the FT-757GX is used with a linear amplifier, the T/R relay in the linear amplifier must be switched by the transceiver. If the linear amplifier is specifically designed for QSK operation, such as the Alpha 78, then the relay in the amplifier can be controlled directly from pin 6 of the BAND DATA jack on the rear of the transceiver, since the amplifier relay coil voltage and current requirement is low for this amplifier.

However, some amplifiers use a relay coil voltage over 50 volts, such as the Heathkit SB-200 or SB-220, or older Henry Linears. Though these amplifiers are not capable of QSK operation, it is still necessary for the transceiver to switch the T/R relay in the linear. The internal control relay in the FT-757GX is not designed to handle high voltage (above 50 V) or current (above 400 mA), and attempting to control linears with such requirements will damage the transceiver.

Therefore, to protect the transceiver, the Yaesu FRB-757 Relay Box should be installed between the amplifier relay jack and the PTT jack on the transceiver. This box contains a large relay designed to handle up to 250 V at 2.5 A. If your linear amplifier is not specifically designed for QSK operation with low relay control voltage and current, we recommend using the FRB-757.

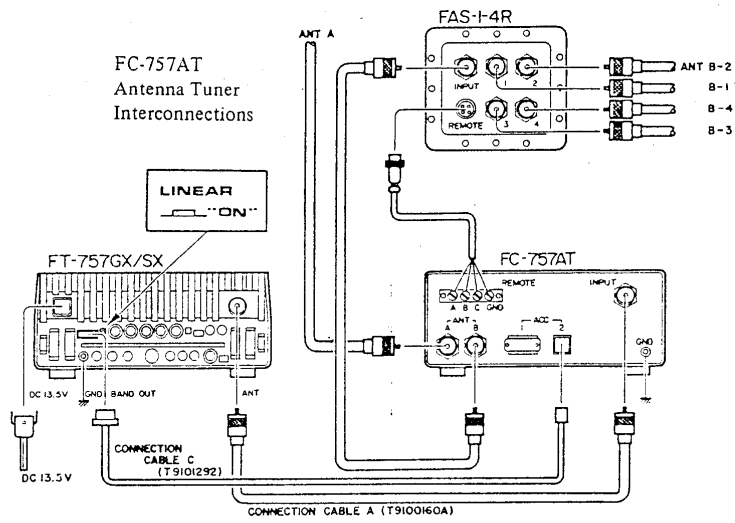

PLUG CONNECTIONS

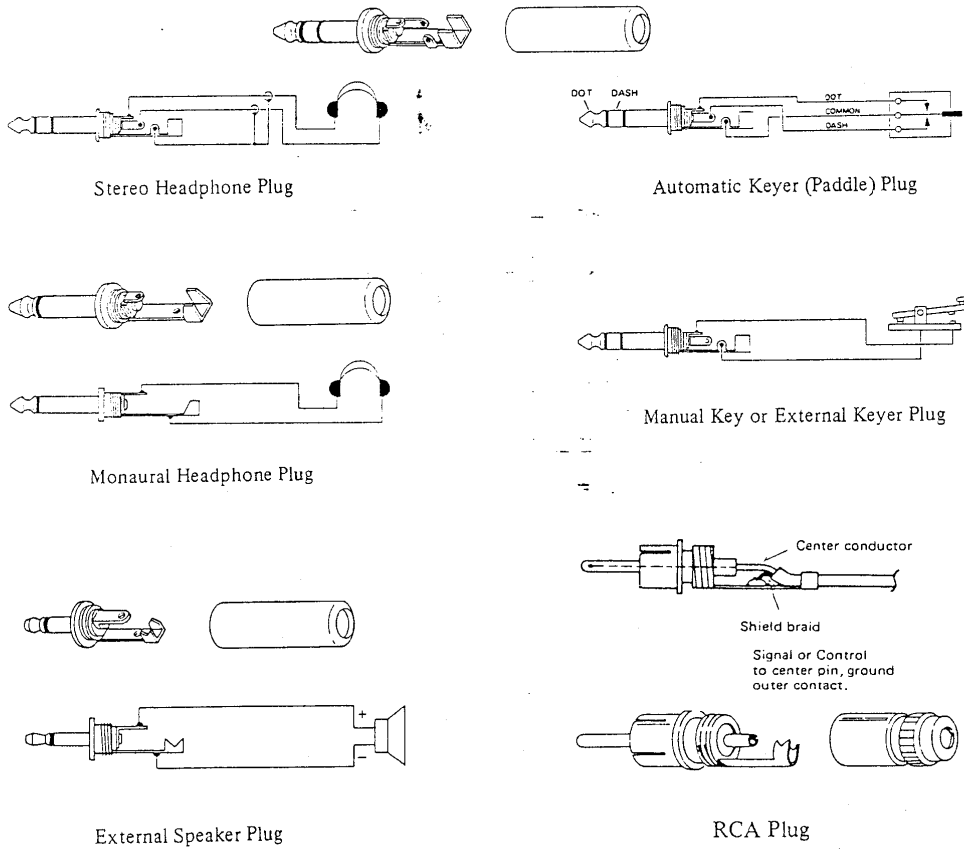

MICROPHONES

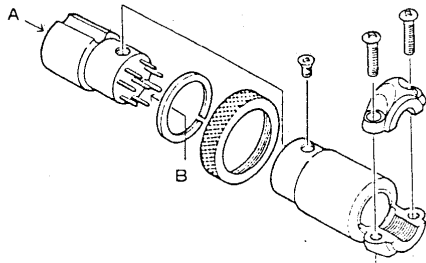

Plug assembly

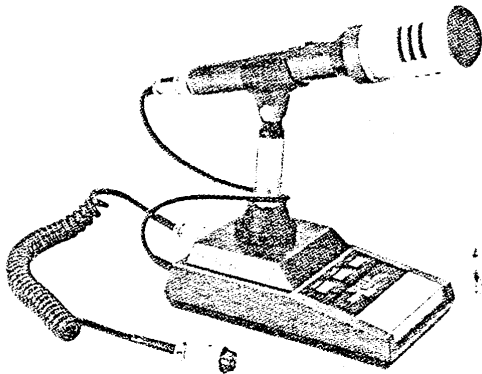

MD-1B8

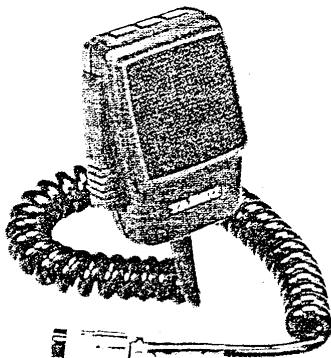
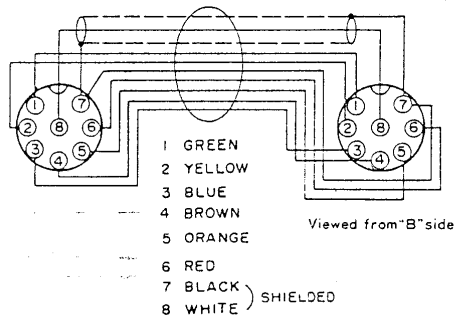
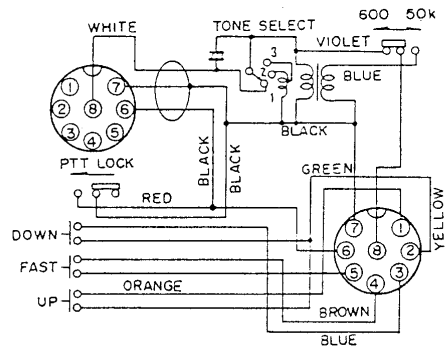
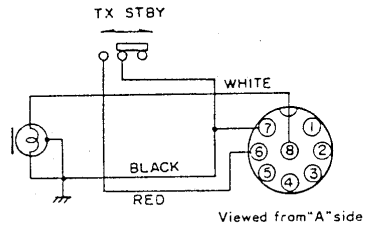

MH-1B8

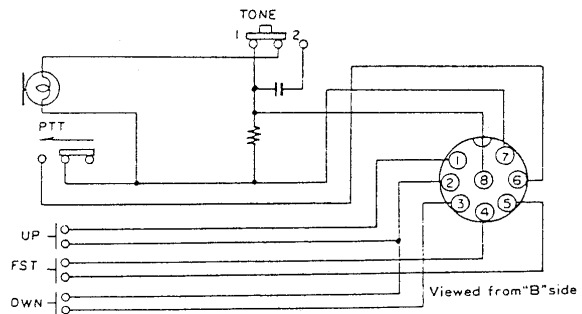

OPERATION

Before switching on the power, check the power supply for proper connection to the transceiver, and proper fuse and wiring for your local AC voltage (if using an AC supply), as described on the previous pages. Also make sure that the antenna or antenna tuner is connected to the antenna jack on the transceiver.

Connect a microphone, if desired, to the MIC jack. See page 21 for microphone information. For CW operation, connect a CW key or keyer paddles to the KEY jack on the rear panel. See page 20 for details of key connections.

Before leaving the factory, the FT-757GX is set so that the memory backup system is disabled, so that there is no drain on the lithium backup battery. To activate the memory backup, simply press both the LINEAR and MARKER switches on the rear panel, so that they are in the out (undepressed) position. During operation, either one may be pressed in without disabling the backup system, but if both are pressed in at the same time when no power is supplied to the transceiver, all memory and VFO data will be cleared. (Normally, the lithium backup battery is only used to retain RAM data when the power is disconnected. As long as power is supplied, even when the transceiver is switched off, the data will be preserved by the DC voltage supplied to the transceiver.)

Preset the POWER switch off, and all of the push buttons to the undepressed position. Set the AF control counterclockwise, and the RF control fully clockwise. Also set the MIC and DRIVE controls fully counterclockwise, and the SQL control fully counterclockwise. Set the SHIFT, WIDTH and NB controls to the 12 o'clock position.

Downloaded by

Amateur Radio Directory

Initial Power Up and Tuning

Make sure the MOX and VOX buttons are in the undepressed position, and then press the POWER button. The meter and display should light, with the display indicating the cleared (default) condition: VFO A and 7.000.0.

Press the large DWN or UP button to select the operating band (for which the antenna is resonant), and then advance the AF control clockwise until noise or signals can be heard from the receiver. Use the tuning knob or scanning buttons on the microphone (if used) to tune the exact desired frequency. The tuning knob tunes in 10 Hz steps, about 10 kHz per revolution.

When using a scanning microphone, the UP and DWN buttons on the microphone will normally scan in 10 Hz steps at about 500 Hz/second. If the FAST button on the microphone is pressed simultaneously, the scanning rate will be about 5 kHz/second.

To tune outside of the normal 500 kHz ranges of the amateur bands, press the 500k STEP button, and then the DWN or UP button. The transceiver will now step through the HF spectrum continuously between 500 kHz to 29.5 MHz. Press the 500k STEP button again to step in the amateur bands only. Use the 500k STEP function also for stepping through the 28–29.7 MHz amateur band.

On the higher frequencies, if more sensitivity is required, press the RF AMP button.

NOTE

Under certain conditions the tuning functions of the tuning knob and microphone scanning buttons will be disabled. These are: when the D LOCK (dial lock), MR (memory recall) or PMS (programmable memory scan) functions are enabled. To determine which function or combination is active, observe the display. If "LOCK" appears to the left of the frequency, press the D LOCK button to disable this function. If "MR" appears to the left of the display, press the MR/VFO button to return control to a VFO. If neither of the above two conditions is present, and the frequency is continually changing, turn the SQL (squelch) control counterclockwise to open the squelch and deactivate the PMS function.

Noise and Interference Reduction

The remaining controls for the receiver (except the VFO and memory control keys) are provided so that the operator can reduce or eliminate the various types of noise, interference and distortion that might otherwise obstruct the clear, comfortable reception of a desired signal. Operation is first described for SSB reception on an amateur band, with the particular variations for other modes described afterwards.

Set the MODE selector to USB and tune to a crowded frequency in the 14, 21 or 28 MHz amateur phone band. Then tune in one particular signal that is being interfered with by other stations on nearby frequencies.

When the interfering stations are either all above or all below the desired signal it is usually only necessary to rotate the outer WIDTH control either to the left or right to cut the interference out of the receiver passband (the SHIFT control will also work for this, but may introduce interference from the other side of the signal).

When interfering stations are on both sides (higher and lower frequencies), first adjust the SHIFT control just to the point where the interference from one side is eliminated, and then rotate the WIDTH control in the opposite direction to eliminate interference from the other side. The optimum setting of these controls depends on the relative strengths and frequencies of the desired and interfering signals, and can be achieved only through practice.

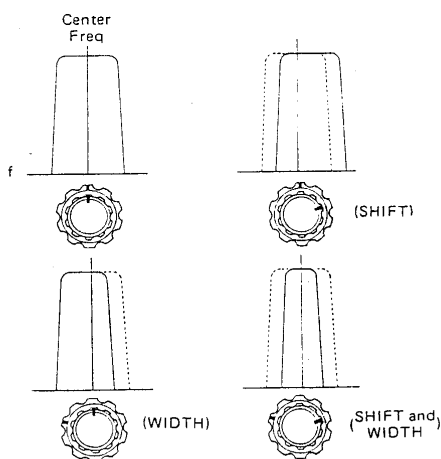

RECEIVE PASSBAND SHIFT AND WIDTH

Except during conditions of extreme crowding, such as during contests, the WIDTH and SHIFT controls should be returned to the 12 o'clock position when tuning the receiver to a new frequency. This will provide the best fidelity and easiest tuning.

While the IF passband adjustments just mentioned will reduce the amount of noise and thereby increase receiver sensitivity, intermodulation products caused by very strong signals on nearby frequencies may still cause unacceptable interference. This can be reduced or removed by switching off the RF AMP (if on), or by activating the attenuator (ATT button). For fine adjustment of receiver attenuation, use the RF gain control. Setting this control to any position except fully clockwise will affect S-meter indication, so it should normally be set fully clockwise.

Under normal conditions of atmospheric noise, reception particularly on frequencies below 10 MHz will generally be more comfortable with the RF AMP button off (out position). Unless the noise picked up by the antenna is less than the receiver noise floor (without the antenna connected), activating the RF AMP will not increase the real receiver sensitivity to weak signals, but will only increase the relative S-meter indications while decreasing dynamic range. Therefore it is recommended that the RF AMP be kept off during low frequency reception, and that the attenuator (ATT) be switched on (depressed) when working strong signals. With a properly matched antenna, the RF AMP will rarely be necessary below 14 MHz, though the increased S-meter indication may be psychologically pleasing.

Pulse-type noise, either short duration types such as from ignition systems and electric motors and switches, or long duration types such as over-the-horizon radar (woodpecker) signals, can be reduced or removed by depressing the NB button and adjusting the NB control from counterclockwise to clockwise just to the point where the noise is removed. Where strong signals are present on nearby frequencies, rotation of the NB control too far clockwise may cause unacceptable intermodulation. Again, optimum performance will be achieved through practice. When noise blanking is not required the NB button should be in the out position.

When fast fading of SSB or CW signals occurs, the AGC-F button may be depressed to improve readability. The fast AGC function is also useful when tuning for weak signals in a crowded band.

When strong, steady signals are present on a fairly clear band, and when waiting on a frequency for a scheduled call, the SQL (squelch) control may be rotated clockwise to squelch off the receiver audio until the expected station calls. However, this function is most useful when waiting for shortwave broadcast stations to come on the air, and for the PMS (programmable memory scanning) function, mentioned later. Normally, the SQL control should be set fully counterclockwise.

CW Reception

In addition to the interference and noise reducing controls mentioned above for SSB, CW reception can be made very comfortable by activating the CW-N mode once the desired signal has been tuned (in the CW-W mode). The CW-N mode activates a 600 Hz crystal filter in the receiver IF, so those signals not within about 300 Hz of the center of the receiver passband will be rejected. The demodulating heterodyne frequency at the center of the passband is 800 Hz when the WIDTH and SHIFT controls are centered.

The CW-W mode provides the same receiver IF bandwidth as for SSB modes but with an internal AF filter to reduce the audio bandwidth, and is useful when searching for an expected call around a predetermined frequency. Noise and interference will be higher than CW-N, but the wider bandwidth facilitates searching and easy tuning. Also, the operator may find fast AGC (AGC-F button depressed) most comfortable for weak-signal CW reception.

The WIDTH and SHIFT controls function in a similar manner as for SSB, but adjustment is more critical. It is recommended that practice be obtained by using these controls in CW-W or SSB modes before attempting to use them for CW-N reception, as the narrower passband of this mode causes the useful adjustment range of these controls to be smaller. If the WIDTH control is adjusted far clockwise from the midrange position, the receiver passband will be cut off completely as the filter skirts will overlap, but by careful

adjustment of these controls it is possible to select receiver passbands of any width and center frequency, between 0 and 600 Hz bandwidth.

The SHIFT control changes the center frequency of the passband, permitting the operator to choose the desired tone pitch at the center of the passband without affecting his transmit frequency. Once the SHIFT control is set to center the desired CW pitch, it should not need readjustment. The WIDTH control performs somewhat differently depending on the direction in which it is adjusted, due to the different shape factors (and hence skirt slopes) of the two filters used in this circuit. However, during CW operation, once the SHIFT control is set, best results will generally be obtained by turning the WIDTH control carefully clockwise from 12 o'clock.

During CW QSOs it is advisable to press the D LOCK button to prevent accidental frequency change.

AM Reception

Because of the relatively wide bandwidth required for proper fidelity during AM reception, the SSB-bandwidth IF filter normally used in the width circuit for SSB and CW is bypassed during AM reception. This allows good fidelity, but necessitates that the WIDTH function be altered. Thus during AM reception the WIDTH control will perform in a similar manner to the SHIFT control, and either may be used to minimize adjacent-channel interference and noise, although the effect of these adjustments will be much less critical than for SSB and CW, and almost unnoticeable on strong signals.

When interference and noise are severe, and the operator is willing to sacrifice fidelity for readability, Exalted Carrier Selectable Sideband (ECSS) reception can be employed by tuning the AM signal with the transceiver set to the SSB position (LSB or USB) that gives the best reception. In this case, the receiver must be tuned to precisely zero beat the received carrier with the internal BFO, and the WIDTH and SHIFT controls can then be used as in regular SSB reception.

During AM reception the noise blanker will generally only blank those noise pulses that are of greater amplitude than the carrier of the signal being received, and some distortion may be noticed on the received signal.

The squelch system can be used effectively when waiting for an AM station to begin broadcasting on a particular frequency. Simply tune the transceiver to the frequency in the AM mode, and set the RF gain control fully clockwise. Then advance the SQL control until the noise is squelched. When the station begins transmitting, the squelch will open and the signal will be heard. Of course, the desired signal must be above the level of noise and other interference on the frequency, and the SQL control must not be set too far clockwise or the signal may not be strong enough to open the squelch.

FM Reception

The FT-757GX is equipped for FM operation without additional accessories. However, since FM is generally not used on frequencies below about 29 MHz, a VHF or UHF transverter such as the FTV-700 (single band) or FTV-107 (dual band) may be desirable to extend the range of the FT-757GX into the amateur bands above 30 MHz.

The WIDTH and SHIFT controls are not used for FM reception, since narrowed or shifted bandwidth would distort the incoming signal objectionably. Also, the noise blanker and AGC functions are not used.

RTTY

An external RTTY modem (terminal unit) is required for RTTY reception and transmission. Audio output from the receiver can be obtained from the AF OUT jack on the rear panel, as the level of the signal at this jack is not affected by the AF gain control. Impedance is 50 kilohms and signal level is 200 mVp-p. If necessary, low impedance output may be obtained from the EXT SP jack, but this is affected by the AF gain control.

The SHIFT/WIDTH system makes the FT-757GX ideal for RTTY reception using the SSB modes. Amateur RTTY generally requires use of the LSB mode, while commercial RTTY can require either LSB or USB. The optimum setting of the WIDTH control is determined by the RTTY shift (usually 170 Hz for amateurs, and 425 or 850 Hz for commercial stations), and the optimum setting of the SHIFT control is determined by the RTTY MARK frequency, which is 2195 Hz generally: except in Europe, where lower frequencies are used. The optimum setting of these controls will provide the best copy with minimum noise, and will be the same for the same RTTY formats, so the positions of these controls should be noted for future use, once they have been determined for common RTTY tones and shifts.

Other controls are used in the same manner as for SSB. However, note that the SQL (squelch) control can be put to good use when waiting for commercial RTTY transmissions on the general coverage frequencies.

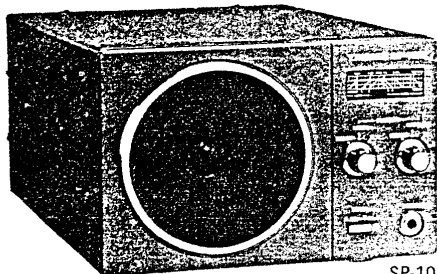

SP-102

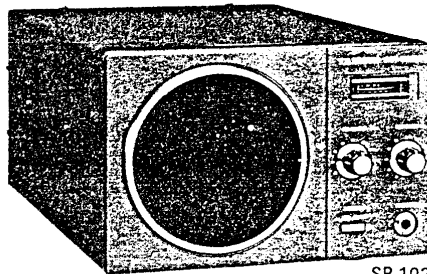

SP-102P

TRANSMITTER OPERATION

The solid state transmitter in the FT-757GX requires no peaking or adjustment once the transmitting frequency has been selected, other than gain setting for the correct power output level. The maximum power output level is determined by the mode and type of power supply being used, and care must be exercised when operating AM, FM or AFSK to restrict power so as to avoid overheating and damage to the supply. Also, there are certain precautions that must be taken at all times when transmitting to avoid possible damage to the transceiver or improper signal transmission.

Never transmit without having a dummy load, or antenna tuned to the transmitting frequency, connected to the transceiver. If there is any doubt about transmitting on a particular antenna at a certain frequency, check the SWR first, as described below.

While transmitting, never move the MODE selector, as to do so could damage the transceiver. Also, avoid changing frequency during transmission. First return to receive, tune to the new transmit frequency, and listen for at least a minute or two to make sure that the new frequency is not already occupied, or ask if the frequency is occupied, and then listen. When using a light or medium duty power supply such as the FP-700, do not attempt to transmit FM, AM or RTTY at full output power. While the transceiver is capable of this, some power supplies are not, and they will rapidly overheat and possibly sustain permanent damage. Also, during long SSB or CW transmissions (or key down CW tests of over 30 seconds), check the supply temperature. If it feels hot, let the equipment cool before transmitting again.

Never begin to transmit when using an antenna without first listening for a few minutes to make sure that the frequency is clear, and then transmit your call sign. This will avoid accidental interference to other stations.

The following procedures describe adjustment of the transmitter for the maximum safe output power for each mode. Exceeding these levels may cause distortion and/or unwanted spurious radiation, as well as excessive heating and shortened equipment life. Yaesu strongly recommends that, once initial contact has been verified, power output be reduced to the minimum level necessary for continuing communication. This can greatly increase the life of the transmitter components while minimizing possible interference to others.

Checking and Measuring SWR

Before transmitting, the SWR of the antenna system should be checked at the operating frequency to ensure that the proper impedance is being presented to the transmitter. The FT-757GX final stages include protection circuits that will automatically reduce the output power if SWR is high, with only about 75% of full power available with an SWR of 3 (to 1).

If using the FC-757AT Automatic Antenna Tuner, SWR is calculated and displayed automatically on the meter of the Tuner, and the following procedures need not be performed. The METER switch on the FT-757GX should then be kept in the ALC position. See the FC-757AT Manual for complete details.

The first procedure to follow checks the approximate SWR using only five to ten watts. Use this procedure whenever the impedance of the load is unknown or in doubt for a particular frequency. The low power will help to minimize strain on the equipment or load, though the SWR indication on the meter will not be as accurate as the later procedure provides. If the load SWR checks below 3 in the low power check, proceed to the high power test. Even though the SWR may have been previously measured and the load impedance known to be close to 50 ohms, it is still advisable to check the SWR occasionally so that any problems that may develop in the antenna system will be detected before possible damage occurs.

During SSB transmission the ALC indication on the meter should be monitored. Sudden shifts of peak ALC level and/or erratic ALC behavior indicate possible problems with the antenna system, and the SWR should be checked immediately. Identify your station before and after checking antenna SWR. To check SWR, the METER switch should be set to the PO (depressed) position, and the MODE selector set to CW-W. Remove the CW key or paddles, if connected. Preset the DRIVE control fully counterclockwise (minimum), and the FWD SET control (on the rear panel) fully clockwise. Set the FWD-REV switch (rear panel) to the FWD position, and tune the transceiver to the test frequency. Listen to make sure the frequency is clear before proceeding.

Now press the MOX button to activate the transmitter, and gradually advance the DRIVE control to obtain full scale indication on the meter (SET mark on the bottom scale). If full scale deflection is not obtained before the DRIVE control reaches the 1 o'clock position, the SWR is too high to warrant operation. If full scale deflection is obtained, move the FWD-REV switch to the REV position, and note the SWR indication on the bottom scale of the meter. Then press the MOX button again (to the out position).

If the SWR indication was much above 3, the antenna system is too far from resonance to be used at the test frequency without substantially degraded performance. SWR indications close to 3 indicate poor antenna matching. However, an antenna tuner such as the FC-757AT can be used to tune the antenna system to provide the proper match at the test frequency. Of course this will not change the radiating qualities of the antenna system itself, and will require retuning whenever the transmitting frequency is changed, so it is better to correct the antenna or feedline mismatch first, if possible.

Little (1.5 or less) or no SWR deflection on the meter indicates a matched antenna system for use at the test frequency. To measure the SWR more precisely at higher power; reduce the FWD SET control, set the METER switch to the ALC position and the FWD-REV switch to be FWD position, press the MOX button and advance the DRIVE control to obtain a slight ALC indication on the meter. Then set the METER switch back to

PO and this time adjust the FWD SET control for full scale deflection (FWD SET mark). Move the FWD-REV switch back to REV, and note the indication on the SWR scale of the meter. Press the MOX button off. Again, if the SWR is above 3 a change in the antenna system or operating frequency is warranted.

Power Meter Calibration

Since the PO meter scale in the FT-757GX is marked in watts, it is possible to calibrate the meter as an RF wattmeter for approximate indication of transmitter output power. This is necessary for proper transmitter adjustment during AM, FM and RTTY transmission, and is helpful for reduced power operation in the other modes. Therefore, once the antenna system SWR has been measured and an acceptable match of the antenna system to the transceiver is indicated, calibrate the PO meter as follows:

With the METER switch set to the PO position, set the FWD-REV switch on the rear panel to the FWD position. Check that the frequency is clear, and then (in the CW-W mode) press the MOX button and adjust the FWD SET control on the rear panel for an indication of 100 W on the PO scale of the meter, when the DRIVE control is set to maximum.

The accuracy of this calibration is generally very rough, since the actual forward power output is substantially affected by the band of operation, as well as any deviation of the antenna system impedance from 50 ohms (resistive). However, it will suffice for proper adjustment of the transmitter for AM, FM and RTTY.

Improved PO meter calibration can be obtained by connecting an external wattmeter of known accuracy to the output along with a 50-ohm dummy load, and making the same adjustment as above to provide the same meter readings on the internal and external wattmeters. Reduce the DRIVE control setting to bring the output power into a measurable range, if necessary.

The FC-757AT Automatic Antenna Tuner includes a wattmeter and 50-ohm dummy load, so the above calibration is not required. Use the wattmeter in the FC-757AT to set power output as necessary.

SSB Transmission

For single sideband transmission without the speech processor, set the METER switch to ALC and preset the MIC gain control to midrange. The DRIVE control is not used.

Tune the transceiver to a clear frequency, and then close the PTT switch and speak into the microphone your callsign and then the word "four" slowly several times while watching the ALC deflection on the meter. Adjust the MIC gain control, if necessary, to produce slight ALC deflection. If the meter indication goes beyond the ALC zone (midrange), reduce the MIC gain setting. Higher levels of ALC do not provide more output power.

Set the METER switch to the PO position to check power output on the meter. Once contact has been established it is usually unnecessary to maintain full power, in which case the MIC gain control should be reduced as much as possible.

VOX Adjustment and Operation

For VOX (voice actuated receive-to-transmit) operation, simply press the VOX button and speak into the microphone without closing the PTT switch. Adjust the VOX control on the rear panel from the fully clockwise position just to the point where the transmitter is activated each time a new phrase is spoken (use normal conversational speech). The hang-time from the end of a sentence to the activation of the receiver can be adjusted with the rear panel DELAY control.

If the audio from the receiver triggers the VOX system, make the above adjustment with the AF control set for low receiver volume, and then increase the volume (in the speaker) to the desired operating level. Now adjust the A-TRIP control on the rear panel just to the point where the receiver audio ceases to key the VOX.

SSB Speech Processor

Once the MIC gain control has been adjusted for the desired safe ALC peak indication on the left half of the meter scale, the PROC button may be depressed to activate the speech processor. While peak ALC indication will not change, the average ALC indication will increase, indicating the

increase in average speech power. If the peak ALC indication on the meter goes above midrange, reduce the MIC gain setting.

The COMP LEVEL control on the rear panel adjusts the level of speech compression by the processor, and is carefully set to the point of optimum performance at the factory. However, use of different microphones and variations in operator voice pitch may make it desirable to readjust this control. This can be done by monitoring the transmitted signal on an oscilloscope and/or external receiver, and adjusting the COMP LEVEL control to the point just below that at which distortion appears on the transmitted signal. If set beyond this point, average power will still be increased, but distortion will cause the intelligibility of the signal to decrease.

Once the COMP LEVEL control has been set for a particular operator and microphone, it should not require readjustment. To reduce power once contact has been established, first press the PROC switch off, and then reduce the MIC gain control as before. To operate the speech processor at reduced power levels, simply reduce the MIC gain control.

CW Transmission

The FT-757GX is capable of either semi or full break-in (QSK) operation for both simplex and split-frequency operation. However, QSK operation must not be attempted when operating the FT-757GX with a linear amplifier not specifically designed for such operation or damage to the amplifier and/or transceiver may result. See page 18 for more information.

Although a straight key can be used for manual CW, keyer paddles are necessary in order to make full use of the 4-bit dedicated electronic keyer microprocessor in the FT-757GX. Connect the key or paddles to the KEY jack on the rear panel, using a three-conductor phone plug connected as shown on page 20. If you prefer to use your own electronic keyer, connect it to the KEY jack using a three-conductor plug. Open circuit voltage is 5 V (center positive), and closed circuit current 0.5 mA. Set the METER switch to the ALC (out) position, and tune to the desired frequency using the CW-W or CW-N mode.

Set the VOX switch on the front panel to the depressed position. Set the KEYER switch on the top panel to the MAN position, and close the key or press the dot paddle to transmit a carrier (if using an external keyer it will be necessary to short the output keying line). Now adjust the DRIVE control to obtain slight ALC deflection on the meter (for full power output).

If using keyer paddles and the internal keyer, set the KEYER switch on the top panel to AUTO, and adjust the SPEED control for the desired keying speed.

The sidetone volume during CW transmission can be adjusted using a small screwdriver. The control for this purpose is accessible through the hole near the rear of the bottom cover.

With the VOX button depressed, semi break-in operation is selected. When using a non-QSK linear amplifier, only semi break-in operation should be used. The hang time (between the moment that the key opens and receiver activation) can be adjusted using the DELAY control on the rear panel (this also controls the VOX delay during voice operation). If the VOX button is not pressed and the BREAK-IN switch is set to SEMI, the sidetone will be heard when the key is closed, but no transmission will occur. This feature can be useful for zeroing in on received signals (by matching the received signal pitch to the sidetone), and for CW practice. For QSK operation, set the BREAK-IN switch on the top cover to FULL, and the VOX button on the front panel to the un-depressed (out) position.

During split-frequency QSK operation, the receiver will automatically provide a brief check of the transmit frequency before switching to the intended receiving frequency, allowing the operator to maintain awareness of activity on both frequencies.

Note: The FT-757GX is capable of high-speed split-frequency QSK operation only when both (RX and TX) frequencies are within the same (500 kHz) band. QSK operation between wider-spaced frequencies is limited to a slower speed, because of the necessary extra filter switching and PLL locking time requirements.

Once CW contact has been established with another station, power can be reduced by rotating the DRIVE control counterclockwise.

FM

The gain of the microphone amplifier during FM transmission is preset internally for 5 kHz deviation, so no adjustment by the operator is necessary. The MIC gain control on the front panel is disabled. RF power output can be adjusted by the DRIVE control, so that the meter just deflects slightly when the METER selector is in the (out) ALC position, for full power operation. To reduce power once contact is made, turn the DRIVE control counterclockwise.

CAUTION

When the FT-757GX is used in mobile operation, or with the FP-757HD power supply, full power FM (and AM or RTTY) transmissions must be limited to one-half hour (30 minutes) or less.

When using the FT-757GX with the FP-757GX high duty-cycle power supply, full power FM transmission is possible, but transmissions must be limited to 30 seconds or less. For longer transmissions, reduce power to 50 watts.

However, when the FP-700, or similar light or medium duty-cycle supply is used, FM transmitter power should be limited to about 50 watts at all times, to avoid overheating and subsequent damage to the power supply.

Regardless of which type of power supply is used, power output should be reduced from the suggested levels if long transmissions (more than 10 minutes) are contemplated, or if the ambient room temperature is very hot or the power supply feels hot to the touch.

Downloaded by

Amateur Radio Directory

AM

Because of the fact that the carrier power is only one fourth of the total PEP power of an AM signal, it must be limited to 25 watts or less when transmitting with the FT-757GX. When the power of the modulating sidebands is added to the carrier power, actual PEP power output will be 100 watts, though this does not show on the meter.

To adjust the FT-757GX properly for AM transmission, first calibrate the PO meter as described on page 27. Then with the MODE selector set to AM, adjust the DRIVE control for 25 watts (carrier power) on the PO meter scale, without speaking into the microphone.

Now set the METER switch to the ALC (out) position, and speak into the microphone while adjusting the MIC gain control just to the point where slight movement of the meter needle can be seen. Power output is now 100 watts PEP.

It is possible to activate the speech processor during AM transmission, by pressing the PROC button. However, if speech processing is necessary in order to maintain contact, it is generally better to switch to an SSB mode.

Use the DRIVE control to reduce power once contact has been established.

The AM CAR control on the rear panel can be used to adjust the modulation percentage for a given carrier level when an oscilloscope is connected to monitor the RF output. This control is carefully adjusted at the factory for 100% modulation when the DRIVE control is adjusted for a carrier level of 25 watts, and the MIC gain control is adjusted to about the same position as required for SSB. However, for lower power AM operation, the AM CAR control can be adjusted for 100% modulation with a lower carrier level. In normal circumstances, no adjustment is necessary.

To set this control for proper operation at full power, an RF voltmeter must be connected to jack J₂₀₀₁ on the Local Unit. Set the mode to CW, and note the voltmeter reading in CW TX. Then return to receive, switch the mode to AM, and adjust the AM CAR potentiometer to obtain exactly 1/2 of the voltage on the meter while transmitting AM with no modulation.

As mentioned in the CAUTION above for FM, AM transmissions should also be kept reasonably short, especially when using the FP-700. Reduce power if the power supply becomes hot.

RTTY

An AFSK generator is required to use the FT-757GX for RTTY transmission. This is connected between the modem (RTTY terminal) and the PATCH jack on the rear panel (600 ohms impedance).

Set the MODE selector to LSB (which will produce normal shift; USB produces inverted shift). To switch from receive to transmit, the PTT jack on the rear panel may be used for automatic systems. Alternatively, the VOX button on the FT-757GX may be pressed for automatic semi break-in RTTY, or the MOX button may be used for manual control.

To adjust the output power, set the METER switch to the ALC (out) position, and adjust the MIC gain control while transmitting until just slight ALC deflection is obtained on the meter. This provides full output power. For reduced power, set the METER switch to the PO (in) position, and with the PO meter calibrated as on page 27, adjust the MIC gain control for the desired output power in watts (approx.).

The FT-757GX is capable of full power RTTY transmission for limited periods when used with one of the heavy duty power supplies, the FP-757GX (30 seconds) or FP-757HD (30 minutes). However, in conditions of high ambient temperature and/or at high altitudes, cooling efficiency is decreased and so power output should also be decreased accordingly. In all installations, it is a good idea to back off on the output whenever a long transmission, such as an RTTY picture, is sent; and even then power supply temperature should be closely monitored.

If using the FP-700, restrict output power to 50 watts maximum.

MULTI-FREQUENCY OPERATION AND MEMORY FUNCTIONS

Clarifier Operation

Pressing the CLAR button once activates the clarifier function when operating on a VFO (A or B), and causes "CLAR" to appear to the left of the frequency on the display. When this function is active, the receiving frequency can be tuned away from the original VFO frequency using the microphone scanning buttons, main knob, or BAND DWN and UP buttons, to anywhere within the entire frequency range of the transceiver, while receiving.

Once the receiving frequency has been tuned away from the VFO frequency, if the PTT line is closed and the transmitter activated, the operating (transmit) frequency will still be the original VFO frequency. Therefore, when contact has been established with another station and you wish to retune his signal in the receiver, use the clarifier function. This will avoid any change to your transmit frequency which would require him to retune.

While the clarifier function is activated, the VFO A/B and MR/VFO buttons are disabled. To cancel the clarifier offset and return receive frequency control to the VFO, just press the CLAR button again. If it is desired to preserve the clarified frequency, press the VFO-M button. This will store the clarified frequency in the primary memory channel, overwriting data previously stored there, without affecting the actual VFO frequency. This is described further in the sections on memory operation later in this manual.

Split-Frequency Operation

It should be apparent from the above description of the clarifier function that it can be used for split-frequency operation; transmitting on the primary VFO frequency and receiving on the clarifier frequency. However, for demanding DXing, an alternative system is available which simplifies split-frequency operation when more than one station is to be called.

In this case, one VFO is used for receiving and the other VFO for transmitting. The SPLIT button activates this function, and the VFO A/B button is used in conjunction with the memory buttons to store and recall the various transmit and receive frequencies. When this SPLIT function is activated, "SPLT" will appear to the left of the frequency on the display.

Further details and examples of this technique are provided after the description of the memory system.

VFO A/B, Memory and PMS Operation

The advanced software programs controlling the FT-757GX allow a wide variety of functions incorporating the VFO A/B and memory functions, some of which have never before been offered in an amateur transceiver. While basic operation is quite simple, there are a few guidelines with which the operator should become familiar in order to avoid becoming confused when using the PMS button and the six VFO and memory control buttons at the upper right of the front panel. Following the instructions and actually practicing the examples below will provide the operator with the experience necessary to make full use of the unique functions of the FT-757GX in his own methods of operation.

In general, the firmware system design in the FT-757GX assumes that a VFO (A or B) is used for actual operation, while the memory channels are used simply for frequency data storage. Therefore the tuning and clarifier functions affect only the VFOs, and are inoperative when memory data is displayed (although the receiver and transmitter are still functional). For the sake of clarity, VFO A will be treated as the primary operating VFO in the following descriptions, with VFO B used in a secondary capacity. In practice, the functions of these two VFOs are completely interchangeable, and the frequency data in one will be retained there when operating on the other.

Note: If operation with the VFOs and memories becomes confusing, it is possible to clear all VFO and memory data to the default frequency (7.000.0) by switching off the transceiver and power supply, and then pressing both the MARKER and LIN AMP switches on the rear panel simultaneously. This will disable the lithium memory backup. When power is again switched on, operation will be on VFO A. Make sure that the MARKER and LIN AMP switches are returned to the undepressed position in order to reactivate the backup system, and be careful not to switch power off when both are pressed unless the memories are to be cleared.

Memory Storage

The eight memory channels in the FT-757GX can be programmed from either VFO A or B, when operating on one of the VFOs. There are two buttons that can be used to transfer the VFO frequency data into a memory channel, VFO→M or VFO←M. The choice of which button to use depends upon which frequency is desired for operation after the memory channel is programmed: if no change in operating (VFO) frequency is desired, then the VFO←M button should be used. If the operating frequency is to be changed to that which is already stored in the memory channel, while the original operating frequency data is to be preserved, then the VFO→M button must be used.

Example 1:

You have just received your new FT-757GX and are in the process of exploring its many fine features, particularly the memory system. You have carefully read the manual thus far and tried the various controls as described so far in the Operation section, and now you would like to

The following diagram illustrates the frequency register scheme of the FT-757GX, and the effects of the buttons controlling data interchange between the registers. The actual source of data in the Primary VFO and Primary Mem CH registers is generally the last VFO (A or B) or memory channel number selected.

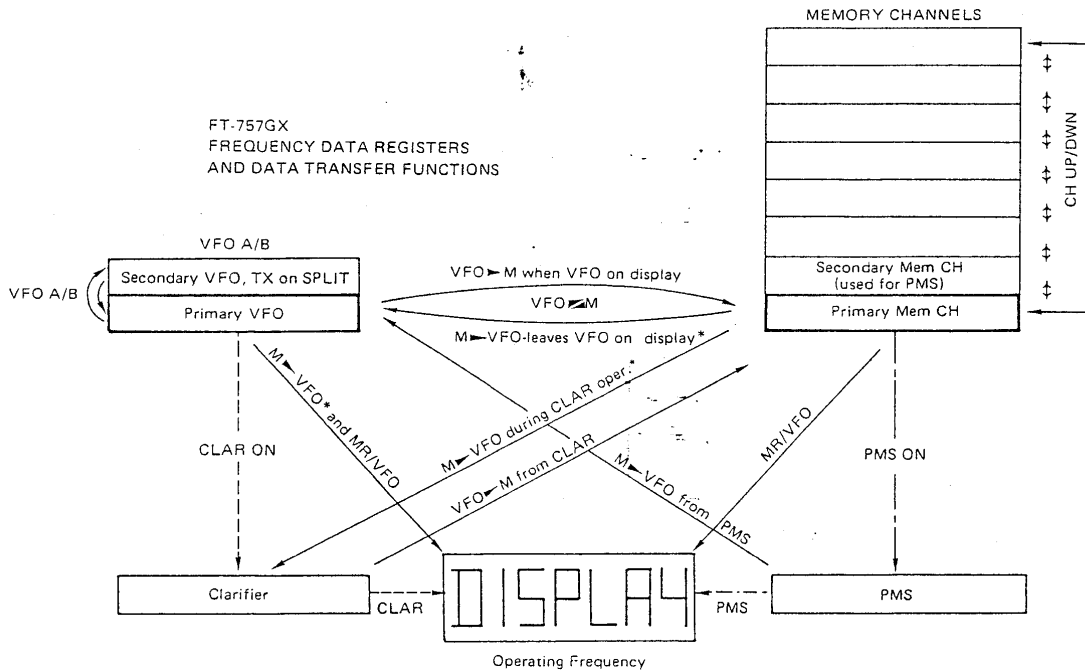

* Do not make this transfer when memory and displayed VFO or clarifier are on different bands.

fill the memories with a number of interesting shortwave broadcast stations that you can hear when you tune to one of the international shortwave broadcast bands (if you haven't tried this yet, press the 500k STEP button and use the BAND keys to tune near 9.5–9.8, 11.7–12, 15.1 – 15.5, 17.7 – 17.9, or 21.45 – 21.75 MHz. Then use the microphone scanning buttons or main knob to tune in an AM station.)

If you want to check the memory contents before storing a new frequency, press the MR/VFO button. Assuming your transceiver has not been used since it left the factory, the display should show "MR 7.000.0 CH 1". Otherwise, it will show the frequency and channel number of the last channel displayed (previously). Press the BAND/CH UP key to check channel 2, and hold this key down to check all channels, returning to channel 1. Now press the MR/VFO button again to return to the VFO.

Having tuned in a station that sounds interesting, press the VFO→M button. This frequency is now stored in memory channel 1. Press the MR/VFO button to confirm this, and press the BAND/CH UP key to move to channel 2. Then press the MR/VFO button again to return to the VFO. Now tune in another station of interest, and press the VFO→M button to store this frequency in channel 2. This process can be repeated until all eight memory channels are programmed.

If you press the VFO↔M button instead of VFO→M, you will find that the operating (VFO) frequency changes to 7.000.0 MHz (or whatever frequency was previously in the memory channel). If you check the contents of the memory channel, you will find the original VFO frequency has now been stored there. To put it back into the VFO without disturbing the memory, press the M←VFO button (while the memory register is displayed).

If you have programmed all eight memory channels, it is still possible to store two more frequencies by using the alternate VFO and the clarifier, though this will limit use of other functions. To store a frequency in the alternate VFO, simply press VFO A/B. Assuming you were operating on VFO A,

operation will now be on VFO B, and the display will show 7.000.0 (unless the VFO A/B function has been used before). The frequency of VFO A is now stored in the secondary VFO register, and can be recalled by pressing the VFO A/B button again.

After storing a frequency in the secondary VFO register, it is possible to store another frequency in the primary VFO register by using the clarifier register for operation. However, transmission on the clarifier frequency is not possible, since the normal function of the clarifier allows for transmission on the primary VFO register only. Nevertheless, since the clarifier can be tuned throughout the entire range of the receiver, it may occasionally prove useful when the operator wishes to retain the data in both VFO registers undisturbed.

Of course when the CLAR button is pressed to switch off the clarifier, operation will return to the primary VFO register, and clarified data will be lost. If you want to save the frequency tuned by the clarifier in the primary memory channel, just press VFO↔M or VFO→M. Neither of these will affect the VFO registers, and if VFO↔M is pressed, the data in the clarifier register is exchanged with the primary memory channel data, which now becomes the operating (clarifier) frequency.

Memory Recall and Transfer

After performing the above example, you know that the MR/VFO button is used to recall the primary memory channel frequency to the display (and operation), and that the BAND/CH UP and DWN keys are used to change the number of the primary memory channel. However, there is an important limitation in using the MR/VFO button to recall the memories: neither tuning nor clarifier operation are possible directly from a memory register.

Therefore, to allow unrestricted operation on a frequency stored in a memory channel, it is first necessary to transfer the memory data into the primary VFO. Two buttons are available for this, and the choice of which to use depends on whether you prefer to preserve the data in the primary VFO in memory (using the VFO↔M button), or not (using the M←VFO button).

Example 2:

Assume you are ragchewing with your friend on 20 meters, and decide that you want to check the propagation forecast being broadcast at 10 MHz by WWV at 18 minutes after the hour. Assume also that you have previously stored 10.000.0 MHz in memory channel 1.

Just before 18 minutes after the hour you tell your friend to wait, and then you press the VFO↔M button to hear the WWV announcement. Just press VFO↔M again to return to your QSO (this will work the same way even during split-frequency QSOs).

Notice that the MR/VFO button could also have been used in this case, but then it would not be possible to tune when the memory was recalled, nor could the clarifier be used, if needed.

Example 3:

Assume you have heard a rare DX station will appear on 14.145 MHz, listening for calls between 14.200 and 14.210 MHz. You have previously stored 14.205 MHz in memory channel 2 (for transmitting), and 14.145 MHz in memory channel 3, and you are having other QSOs.

When the time comes for the DX station to appear, press the MR/VFO button and the BAND/CH DWN or UP keys until memory channel 2 appears on the display. Now press M↔VFO, to move the DX station's receiving frequency into the primary VFO (the one you used last). Operation will shift to the VFO, which is now set to 14.205 MHz.

Press the VFO A/B button to exchange the VFOs, and press the MR/VFO button to recall the memories. Now press the BAND/CH UP key once (to move to channel 3), and press the M↔VFO button to shift the DX station's transmitting frequency into the (other) VFO. Press the SPLIT button and tune in the DX station. When you close the PTT line, you will be transmitting on 14.205 MHz.

To listen on your transmitting frequency (or to change it), just press the VFO A/B button while receiving (but be sure to press it again before you transmit).

The above technique, using the M↔VFO button while operating on the memory channel to transfer data into the VFOs, preserves the frequency data stored in the memories for possible use later. However, frequency data previously held in the VFOs is erased. A combination of the techniques in the last two examples provides an alternative method to accomplish the same end, except that the original VFO contents can be preserved in place of the memories.

Example 4:

Assume the same situation as in Example 3, with the same frequencies already stored in memories 2 and 3.

When it is time to listen for the DX station, press the MR/VFO button and the BAND/CH DWN or UP keys until memory channel 2 appears on the display. Now press VFO↔M to swap data, putting 14.205 MHz into the VFO, and the VFO frequency into channel 2.

Press the VFO A/B button to exchange VFOs (this will occur even though you still see "MR" and channel 2 on the display), and press the BAND/CH UP key to move to channel 3. Now press the M↔VFO button to transfer the data from channel 3 to the VFO. Notice that operation is also shifted to the VFO on 14.145 MHz, where you can now tune in the DX station. Just push the SHIFT button and close the PTT line to call on 14.205 MHz.

If you succeed in working the DX station you can quickly return to your previously VFO frequency by pressing MR/VFO, selecting memory channel 2, and pressing M↔VFO. Operation will shift automatically to the VFO.

This technique is probably the fastest, but it still involves the sacrifice of data previously stored in the secondary VFO. To save this data in a memory, use the VFO↔M button to make the transfer from channel 3 to the VFO, and then press the MR/VFO button to shift operation to the VFO manually. The original data from both VFOs will now be available for recall from channels 2 and 3.

Once you have become familiar with the VFO/memory transfer functions used in the preceding examples, experiment with the transfer functions to determine those most convenient and time-saving in your own type of operation. Net operators will generally find it most convenient to retain net frequencies and net QSY frequencies in the memories, while DX hounds and contesters will want to change the memories regularly during operation.

One word of caution is in order, regarding the transfer function of the M→VFO button. If the display is showing the VFO frequency, and this frequency is in a different band than the memory channel frequency to be transferred, the M→VFO button must not be pressed until after the MR/VFO button is pressed (to change the display to the memory frequency). Otherwise, the displayed frequency of the VFO will still change, but the front-end receiver bandpass filter will not be switched, resulting in degraded operation.

PMS (Programmable Memory Scan) Operation

The PMS function of the FT-757GX provides the capability for the receiver to scan between any two frequencies within the range of the receiver, and to stop automatically on any signal with strength above a preset level. The frequency limits are those stored in the (last) selected memory channel and in the next higher-numbered channel (unless channel 8 is the selected channel, in which case the frequency in channel 1 will be the other limit).

The signal level at which the scanning will halt is set by the SQL (squelch) control, for all modes. Scanning continues until the squelch is opened, and therefore it can also be halted manually by turning the SQL control counterclockwise.

Before activating the PMS function, program the desired scanning frequency limits into two adjacent memory channels, using the techniques described in the previous section. It does not matter which is the higher frequency of the two channels, nor how near the frequencies are to each other. Also, make all positioning and/or tuning adjustments to

the antenna system, and set the RF AMP, ATT, NB and RF gain controls to the anticipated optimum positions (these adjustments and settings must be made before the squelch is closed, since each affects the squelch threshold point).

Now tune the VFO to a clear spot on the band (or to a signal that is weaker than those you wish to have the scanner stop on), and rotate the SQL control clockwise just to the point where the receiver stays silent.

Press the PMS button to activate the scanner. Notice that the display now shows "MR" to the left of the displayed frequency, and "P" under the CH to the right. When the scanner locates a signal above the preset squelch threshold, the squelch will open and scanning will stop on that frequency. To resume scanning, just rotate the SQL control further clockwise to squelch off the signal, press the PMS button again, and return the SQL control to its original position.

When the scanner stops on a desired signal, and you wish to terminate the PMS function there, press the M→VFO button once. This will transfer operation on the scanned frequency into the VFO. Note that the function of the M→VFO button is different in this case than when the PMS function is not in use. In fact, if the M→VFO button is pressed twice when the scanner has halted on a frequency, the first push will function as described here, but the second push will cause the VFO frequency displayed to change again to that of the last selected memory channel. However, this second push may cause improper operation if the frequencies are widely different, as cautioned in the paragraph preceding this the PMS description.

Example 5:

Assume that you would like to use the FT-757GX to listen to the downlink of one of the amateur satellites transmitting on the 28 MHz band (or VHF or UHF bands, using a transverter). You know the approximate direction from which it will appear over the horizon, and have pointed your antenna in that direction, but you do not know what time it will appear, or the exact frequency.

Scan by Dan

Downloaded by

Amateur Radio Directory

Using the techniques described in the earlier examples, store the upper and lower limits of the satellite subband (approximately 29.3 to 29.5, 145.8 to 145.99 or 435.0 to 435.5 MHz, for example). Switch the RF AMP on, and the Attenuator off. Rotate the RF gain control fully clockwise, and turn the SQL control clockwise just until the background noise is silenced.

You are now free to go about other activities while the FT-757GX listens for the satellite. Almost as soon as it rises above the horizon, the general beacon should cause the squelch to open, thus alerting you to the presence of the satellite. You can then press M-VFO, and tune the VFO to the downlink frequency. Notice that the PMS system is not affected by shifts in the beacon frequency caused by the doppler effect.

If the squelch opens and the scanner stops on an undesired signal, simply rotate the SQL control clockwise, press the PMS button, and return the SQL control to its original position.

Other uses for the PMS function could include automatic checking for band openings, awaiting scheduled calls or nets to start, and exploration of general coverage frequencies.

FT-757GX HF FREQUENCY SPECTRUM CHART

